



To: Planning Committee  
From: Wayne Craig  
Director of Development

Date: September 4, 2019  
File: RZ 18-839945

Re: Application by Konic Development Ltd. for Rezoning at 4571, 4591, and 4611/4631 Steveston Highway from "Single Detached (RS1/E)" and "Two-Unit Dwellings (RD1)" to "Low Density Townhouses (RTL4)"

**Staff Recommendation**

That Richmond Zoning Bylaw 8500, Amendment Bylaw 10081, for the rezoning of 4571, 4591, and 4611/4631 Steveston Highway from "Single Detached (RS1/E)" and "Two-Unit Dwellings (RD1)" to "Low Density Townhouses (RTL4)," be introduced and given first reading.

  
Wayne Craig  
Director of Development

WC:jr  
Att. 6

REPORT CONCURRENCE		
ROUTED TO:	CONCURRENCE	CONCURRENCE OF GENERAL MANAGER
Affordable Housing	<input checked="" type="checkbox"/>	

## Staff Report

### Origin

Konic Development Ltd. has applied to the City of Richmond for permission to rezone 4571, 4591, and 4611/4631 Steveston Highway from the “Single Detached (RS1/E)” and “Two-Unit Dwellings (RD1)” zones to the “Low Density Townhouses (RTL4)” zone, in order to develop 16 townhouse units and one secondary suite with vehicle access from Steveston Highway. A location map and an aerial photo are provided in Attachment 1.

### Findings of Fact

A Development Application Data Sheet providing details about the development proposal is provided in Attachment 2.

#### Subject Site Existing Housing Profile

The subject site contains two single family dwellings and one duplex, all of which would be demolished. The applicant has indicated that all four dwellings were previously owner-occupied.

### Surrounding Development

Development immediately surrounding the subject site is generally as follows:

- To the North: single family dwellings fronting Bonavista Drive on lots zoned “Single-Detached (RS1/B).”
- To the South, across Steveston Highway: single family dwellings on lots zoned “Single-Detached (RS1/B).”
- To the East: a single family dwelling on a lot zoned “Single Detached (RS1/E).”
- To the West: a single family dwelling on a lot zoned “Single Detached (RS1/E).”

### Related Policies & Studies

#### Official Community Plan/Steveston Area Plan

The subject site is located in the Steveston planning area, and has an Official Community Plan (OCP) designation of “Neighbourhood Residential.” The land use designation in the Steveston Area Plan is “Multiple Family” (Attachment 3). The proposed rezoning is consistent with these designations.

#### Arterial Road Policy

The subject site is located on an arterial road identified in the Arterial Road Land Use Policy, and has a land use designation of “Arterial Road Townhouses.” The proposed rezoning is consistent with this designation.

The proposed development involves three properties with a total frontage of 61.89 m on Steveston Highway, which is consistent with the minimum 50 m frontage suggested for major arterial roads in the Arterial Road Land Use Policy. Future lot consolidation to the east of the subject site would fall short of this minimum, at 48.47 m, however this should not be a barrier to future redevelopment.

Prior to final adoption of the rezoning bylaw, the applicant is required to grant a Statutory Right-of-Way for Public Rights-of-Passage across the entire drive aisle, which would allow future developments to the east and west the option to share the driveway access to Steveston Highway.

#### Affordable Housing Strategy

As per the City's Affordable Housing Strategy, townhouse rezoning applications are required to provide a cash-in-lieu contribution of \$8.50 per buildable square foot towards the City's Affordable Housing Reserve Fund. The applicant proposes to make a cash-in-lieu contribution of \$164,798, which is consistent with the Affordable Housing Strategy.

#### Public Art Program Policy

The applicant will be participating in the City's Public Art Program by making a voluntary contribution to the City's Public Art Reserve fund for City-wide projects on City lands. Since this rezoning was received in 2018, the applicable rate for the contribution is \$0.85 per buildable square foot; for a total contribution in the amount of \$16,480. This voluntary contribution is required to be submitted to the City prior to final adoption of the rezoning bylaw.

#### Floodplain Management Implementation Strategy

The proposed redevelopment must meet the requirements of the Richmond Flood Plain Designation and Protection Bylaw 8204. Registration of a flood indemnity covenant on Title is required prior to final adoption of the rezoning bylaw.

#### **Public Consultation**

A rezoning sign has been installed on the subject property. Staff have not received any comments from the public about the rezoning application in response to the placement of the rezoning sign on the property.

Should the Planning Committee endorse this application and Council grant 1<sup>st</sup> reading to the rezoning bylaw, the bylaw will be forwarded to a Public Hearing, where any area resident or interested party will have an opportunity to comment. Public notification for the Public Hearing will be provided as per the *Local Government Act*.

#### **Analysis**

##### Built Form and Architectural Character

The applicant proposes nine three-storey townhouse units and seven two-storey townhouse units arranged on an L-shaped central drive aisle. Conceptual development plans are included in Attachment 4.

The proposed site layout consists of:

- two three-storey buildings, containing nine three-storey units and one two-storey unit, for a total of ten units, fronting Steveston Highway; and
- three two-storey buildings, containing a total of six units, along the north end of the site.

The two proposed buildings fronting Steveston Highway each contain five units. Secondary eaves break up the vertical massing on the first and second storeys, and projecting gable ends highlighting the unit entries. Roof gables framing the upper storey windows and decorative elements portray a strong traditional residential character. A secondary suite is proposed to be located in Unit 102.

The three proposed buildings at the rear of the site each contain two two-storey townhouse units in order to present a gradual transition to the adjacent single family neighbourhood. These buildings include similar architectural details as those on Steveston Highway, including secondary eaves above the first storey and use of gable ends to frame upper storey windows. Unit 111 is proposed to be a convertible unit. The provision of a second convertible unit will be included in the Development Permit review process.

Further refinement of the site plan, architectural character, and accessibility features will occur through the Development Permit process.

#### Variance Requested

The proposed development is generally in compliance with the “Low Density Townhouses (RTL4)” zone in Richmond Zoning Bylaw 8500, with the exception of a variance to decrease the front yard setback from 6.0 m to 4.92 m. The building face would be approximately 8.72 m from back of curb.

Staff is supportive of this variance as the shift in building massing towards Steveston Highway is a direct result of providing a 6.0 m rear yard setback to the adjacent single family properties. In addition to providing a sensitive interface with the adjacent properties, the deeper setback allows for an existing row of off-site trees to be retained.

#### Amenity Space

The applicant is proposing a cash contribution in-lieu of providing the required indoor amenity space on site, at the applicable rate established in the OCP (i.e. \$1,600/unit for applications received prior to February 28, 2019). The total cash contribution for this 16-unit townhouse development is \$25,600.

A common outdoor amenity space is proposed at the northwest end of the site, directly across from the entry drive aisle. The size and dimensions of the proposed outdoor amenity space are consistent with the OCP. The proposal includes landscaping, seating, and a large play structure suitable for children. Further refinement of the common outdoor amenity space will occur through the Development Permit process.

### Transportation and Site Access

Vehicle access is proposed from Steveston Highway, via a driveway located at the western edge of the subject site. The driveway crossing will be designed to restrict vehicle movements to a “right in, right out” turning pattern. The applicant is required to register a statutory right-of-way across the entire drive aisle in order to accommodate access to future developments to the east and west of the subject site.

Two parking spaces are provided for each unit consistent with the Zoning Bylaw. Seven of the sixteen units have parking in a tandem arrangement. The applicant is required to register a legal agreement on Title ensuring that the areas used for tandem parking are not converted to habitable space.

The applicant has agreed to provide a \$5,700 cash-in-lieu contribution for upgrades to the existing special crosswalk at the Steveston Highway and Bonavista Gate intersection. Upgrades will include LED street light luminaire, intersection lighting, and Audio Pedestrian Signals.

### Tree Retention and Replacement

The applicant has submitted a Certified Arborist’s Report; which identifies on-site and off-site tree species, assesses tree structure and condition, and provides recommendations on tree retention and removal relative to the proposed development. The Report assesses four bylaw-sized trees on the subject property, six trees on a neighbouring property, and two street trees on City property.

The City’s Tree Preservation Coordinator has reviewed the Arborist’s Report and supports the Arborist’s findings, with the following comments:

- Four trees (Tag # 927, 928, 929, and 930) located on the development site have either been historically topped, or exhibit structural defects such as cavities at the main branch union and co-dominant stems with inclusions. As a result these trees are in poor condition and are not good candidate for retention. Remove and replace.
- One Cedar windrow (Tag # N01) comprised of six trees located on an adjacent property to the north of the development site is to be retained and protected. Provide tree protection as per City of Richmond Tree Protection Information Bulletin Tree-03.
- Replacement trees should be specified at 2:1 ratio as per the OCP.

Parks staff have reviewed the Arborist’s Report and support the Arborist’s finding, with the following comments:

- One Black locust tree (Tag # C01) and one Western red cedar tree (Tag # C02) are in poor condition and have been topped to accommodate the overhead hydro lines. Removal is recommended. Replacement boulevard trees to be planted through the Servicing Agreement for frontage works.
- In addition to new trees planted through the Servicing Agreement, the developer is required to contribute \$2,600 to the City’s Tree Compensation Fund for the removal of these two trees.

### *Tree Protection*

Six trees (Tag # N01) on a neighbouring property are to be retained and protected. In addition, a Cedar hedge located on a neighbouring property to the west of the subject site will be retained and protected. The applicant has submitted a tree protection plan showing the trees to be retained and the measures taken to protect them during development (Attachment 5). To ensure that the trees identified for retention are protected at development stage, the applicant is required to complete the following items:

- Prior to final adoption of the rezoning bylaw, submission to the City of a contract with a Certified Arborist for the supervision of all works conducted within or in close proximity to tree protection zones. The contract must include the scope of work required, the number of proposed monitoring inspections at specified stages of construction, any special measures required to ensure tree protection, and a provision for the arborist to submit a post-construction impact assessment to the City for review.
- Prior to demolition of the existing dwelling on the subject site, installation of tree protection fencing around all trees to be retained. Tree protection fencing must be installed to City standard in accordance with the City's Tree Protection Information Bulletin Tree-03 prior to any works being conducted on-site, and remain in place until construction and landscaping on-site is completed.

### *Tree Replacement*

The applicant wishes to remove four on-site trees (Trees # 927-930). The 2:1 replacement ratio would require a total of eight replacement trees. The applicant has proposed to plant 21 trees on the development site. The required replacement trees are to be of the following minimum sizes, based on the size of the trees being removed as per Tree Protection Bylaw No. 8057.

No. of Replacement Trees	Minimum Caliper of Deciduous Replacement Tree	Minimum Height of Coniferous Replacement Tree
6	11 cm	5.5 m
2	10 cm	6 m

In addition to the replacement trees planted on-site, the applicant will contribute \$2,600 to the City's Tree Compensation Fund for the two City-owned trees being removed.

### BC Energy Step Code

On July 26, 2018, Council adopted BC Energy Step Code requirements for all new residential developments. The proposed development consists of townhouses that staff anticipates would be designed and built in accordance with Part 9 of the BC Building Code. As such, this development would be expected to achieve Step 3 of the Energy Step Code for Part 9 construction (Climate Zone 4).

### Existing Legal Encumbrances

There are two restrictive covenants registered on Title of 4611/4631 Steveston Highway. One covenant (RD85670) reserves a portion of the property for future lane construction by the City. This covenant was secured as a condition of the development of several properties in 1979, and it was the intent at the time for a rear lane to be established from Ransford Gate and Bonavista Gate. However, the land use designation was revised on December 19, 2016, to allow Arterial Road Townhouses with vehicle access from Steveston Highway. As the City is no longer pursuing a rear lane in this location the covenant should be discharged prior to adoption of the rezoning bylaw.

The second covenant (BF506485) restricts the property to a two-unit dwelling only. This covenant must be discharged prior to adoption of the rezoning bylaw.

In addition, there are several statutory rights-of-ways (SRW) for utilities registered on the Titles of each property. These SRWs will not be impacted by the proposed rezoning, and the applicant is aware that encroachment into the SRW areas is not permitted.

### Site Servicing and Frontage Improvements

The applicant is required to enter into a Servicing Agreement at Building Permit stage for the design and construction of the required site servicing and frontage improvements, as described in Attachment 6. Frontage improvements include, but may not be limited to, the following:

- Removal of existing sidewalk and replacement with a new 1.5 m concrete sidewalk at the property line and minimum 1.5 m wide landscaped boulevard with street trees behind the existing curb;
- Removal of the existing driveway crossings and replacement with the frontage works described above; and
- Construction of a new driveway crossing designed to provide “right in, right out” access to the site.

### Development Permit Application

A Development Permit application is required to be processed to a satisfactory level prior to final adoption of the rezoning bylaw. Further refinements to architectural, landscape, and urban design will be completed as part of the Development Permit application review process, including, but not limited to, the following:

- Compliance with the Development Permit Guidelines for multi-family developments and arterial road townhouses in the OCP.
- Refinement of the proposed building form and architectural character to achieve an engaging streetscape along Steveston Highway.

- Review of the size and species of on-site trees to ensure bylaw compliance and to achieve a mix of coniferous and deciduous species.
- Design of the common outdoor amenity space, including choice of play equipment and other features to ensure a safe and vibrant environment for children's play and social interaction.
- Review of accessibility features, including aging-in-place features in all units, and the provision of two convertible units.
- Review of a sustainability strategy for the development proposal, including steps to achieve Step 3 of the Energy Step Code for Part 9 construction (Climate Zone 4).

### **Financial Impact**

This rezoning application results in an insignificant Operational Budget Impact (OBI) for off-site City infrastructure (such as roadworks, waterworks, storm sewers, sanitary sewers, street lights, street trees and traffic signals).

### **Conclusion**

The purpose of this application is to rezone 4571, 4591, and 4611/4631 Steveston Highway from the "Single Detached (RS1/E)" and "Two-Unit Dwellings (RD1)" zones to the "Low Density Townhouses (RTL4)" zone, in order to develop 16 townhouse units and one secondary suite with vehicle access from Steveston Highway.

The rezoning application complies with the land use designations and applicable policies contained within the OCP for the subject site. Further review of the project design will be completed as part of the Development Permit application review process.

The list of rezoning considerations is included in Attachment 6, which has been agreed to by the applicant (signed concurrence on file).

It is recommended that Richmond Zoning Bylaw 8500, Amendment Bylaw 10081 be introduced and given first reading.



Jordan Rockerbie  
Planning Technician – Design  
(604-276-4092)

JR:rg

Attachment 1: Location Map and Aerial Photo  
Attachment 2: Development Application Data Sheet  
Attachment 3: Steveston Area Plan Land Use Map



Attachment 4: Conceptual Development Plans

Attachment 5: Tree Management Plan

Attachment 6: Rezoning Considerations



City of  
Richmond

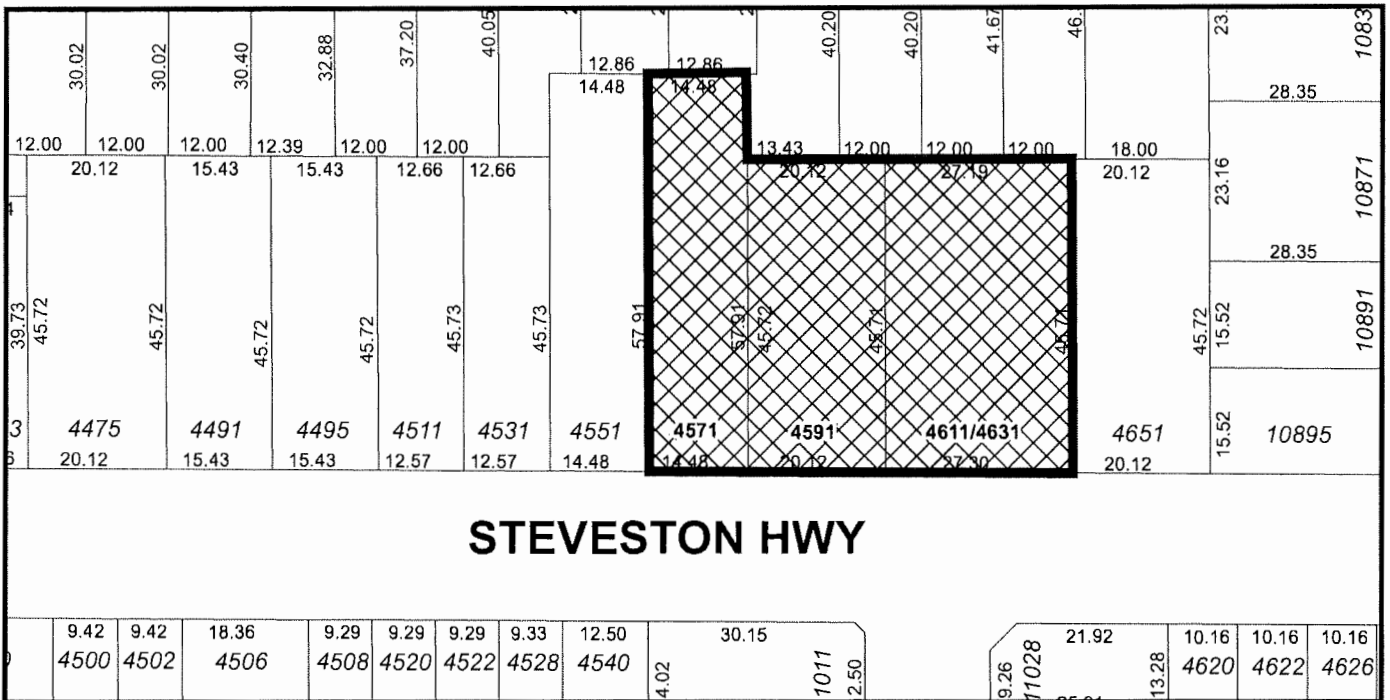
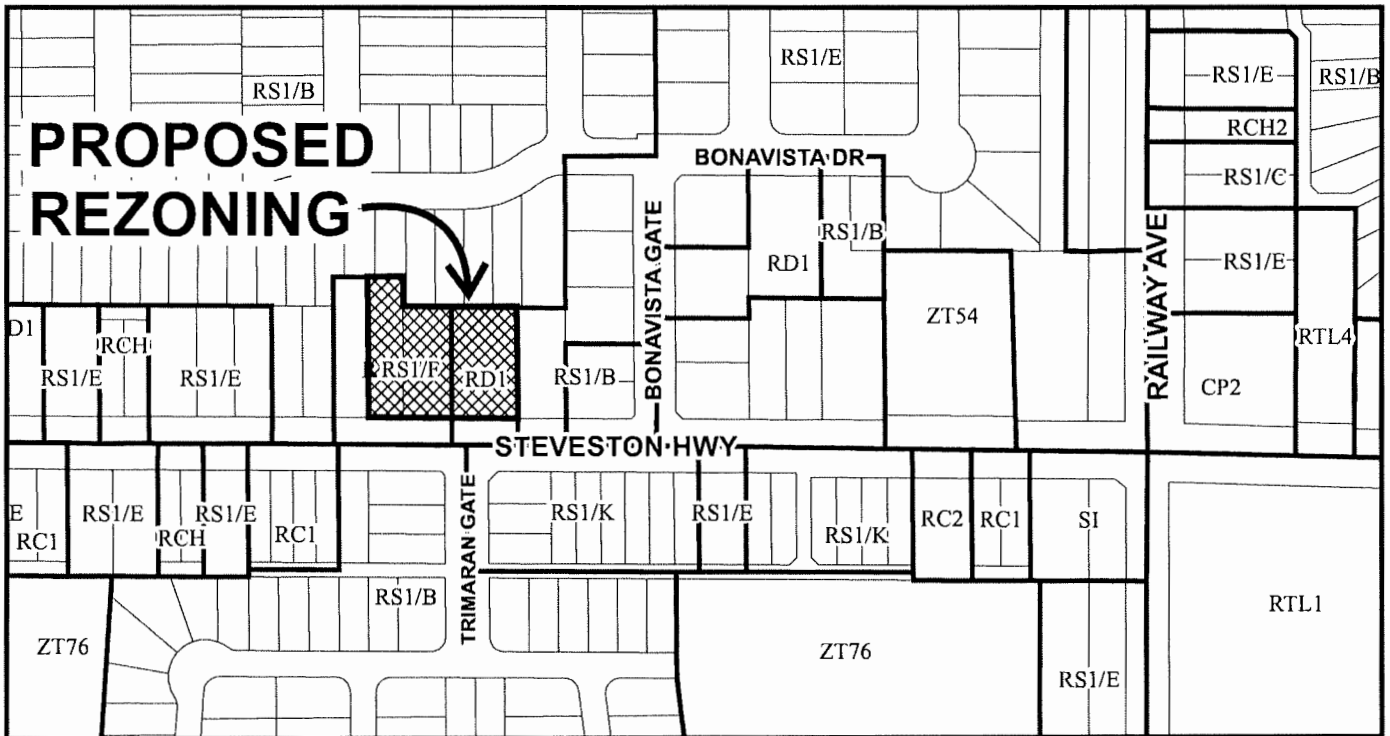

STEVESTON HWY

	<h1>RZ 18-839945</h1>	Original Date: 11/21/18 Revision Date: 11/21/18 Note: Dimensions are in METRES
CNCL - 242		



City of  
Richmond

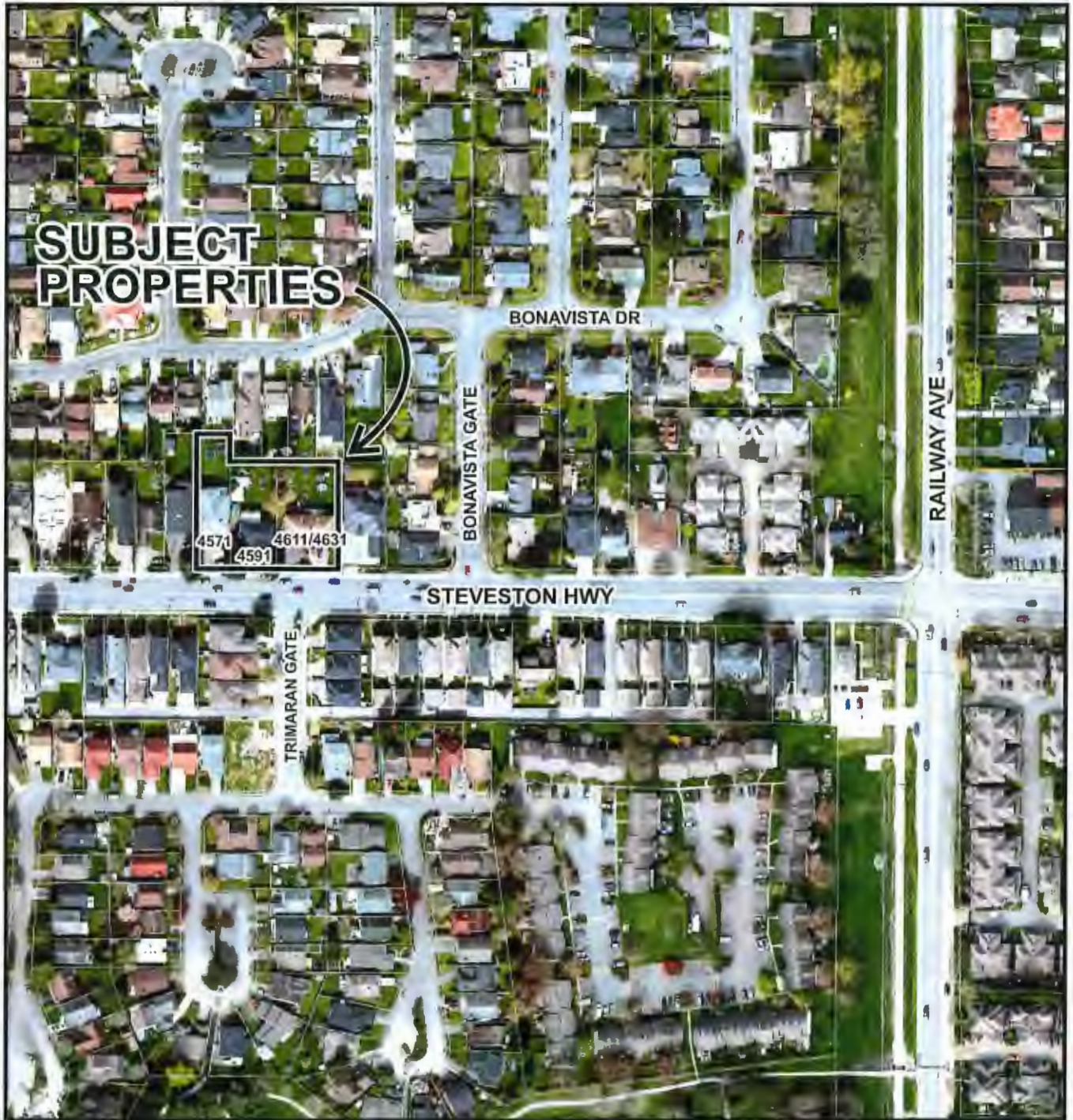

RZ 18-839945

Original Date: 11/21/18

Revision Date:

Note: Dimensions are in METRES

CNCL - 243



**RZ 18-839945**

**Attachment 2**

Address: 4571, 4591, and 4611/4631 Steveston Highway

Applicant: Konic Development Ltd.

Planning Area(s): Steveston

	Existing	Proposed
<b>Owner:</b>	Luxor Homes & Developments, Ltd. 0780012 BC Ltd. 2517294 Ontario Inc. Gurpreet Mann Narinder Mann	To be determined
<b>Site Size (m<sup>2</sup>):</b>	3,002 m <sup>2</sup>	No change
<b>Land Uses:</b>	Single-family and duplex dwellings	Townhouse dwellings
<b>OCP Designation:</b>	Neighbourhood Residential	No change
<b>Area Plan Designation:</b>	Multiple-Family	No change
<b>Zoning:</b>	Single Detached (RS1/E) Two-Unit Dwellings (RD1)	Low Density Townhouses (RTL4)
<b>Number of Units:</b>	2 single-family dwellings 1 duplex dwelling	16 townhouse dwellings 1 secondary suite
<b>Other Designations:</b>	Arterial Road Townhouses	No change

On Future Subdivided Lots	Bylaw Requirement	Proposed	Variance
Floor Area Ratio:	Max. 0.60 FAR	0.60 FAR	none permitted
Buildable Floor Area (m <sup>2</sup> ):*	Max. 1,801 m <sup>2</sup> (19,388 ft <sup>2</sup> )	1,799 m <sup>2</sup> (19,373 ft <sup>2</sup> )	none permitted
Lot Coverage (% of lot area):	Building: Max. 40% Non-porous Surfaces: Max. 65% Live Landscaping: Min. 25%	Building: Max. 40% Non-porous Surfaces: Max. 65% Live Landscaping: Min. 25%	none
Lot Size:	N/A	3,000 m <sup>2</sup>	none
Lot Dimensions (m):	Width: 50.0 m Depth: 35.0 m	Width: 61.89 m Depth: 45.70 m	none
Setbacks (m):	Front: Min. 6.0 m Rear: Min. 3.0 m Side: Min. 3.0 m	Front: 4.9 m Rear: 6.01 m Side (West): 7.05 m Side (East): 3.05 m	<b>Vary front yard setback</b>
Height (m):	12.0 m	11.97 m	none

<b>On Future Subdivided Lots</b>	<b>Bylaw Requirement</b>	<b>Proposed</b>	<b>Variance</b>
Off-street Parking Spaces – Regular (R) / Visitor (V):	2 (R) and 0.2 (V) per unit	2 (R) and 0.25 (V) per unit	none
Off-street Parking Spaces – Total:	36 (up to 50% small car)	36 (8 small car)	none
Tandem Parking Spaces:	Permitted – Maximum of 50% of required spaces	14, i.e. 38%	none
Amenity Space – Indoor:	Min. 50 m <sup>2</sup> or cash-in-lieu	Cash-in-lieu (\$25,600)	none
Amenity Space – Outdoor:	Min. 96 m <sup>2</sup>	198.5 m <sup>2</sup>	none

Other: Tree replacement compensation required for loss of significant trees.

\* Preliminary estimate; not inclusive of garage; exact building size to be determined through zoning bylaw compliance review at Building Permit stage.

City of Richmond

**Steveston Area Land Use Map**

Bylaw 9604  
2016/12/19

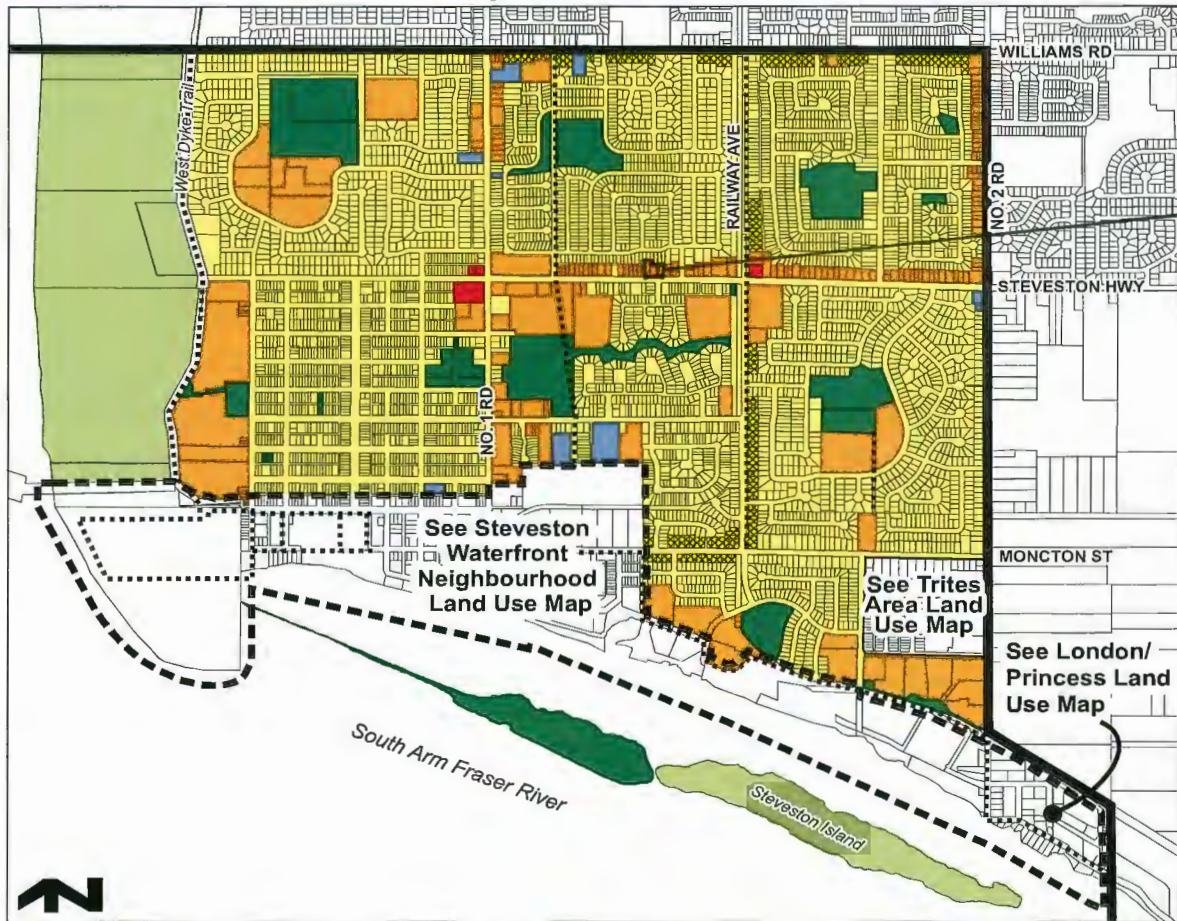

	Single-Family		Institutional
	Single-Detached/Duplex/Triplex		Conservation Area
	Multiple-Family		Trail
	Commercial		Steveston Area Boundary
	Public Open Space		Steveston Waterfront Neighbourhood Boundary



ACQUISITIVE  
DESIGN  
PLANNING

Copyright Reserved  
All rights reserved. No part of this publication may be reproduced, stored in a retrieval system, or transmitted, in any form or by any means, electronic, mechanical, photocopying, recording, or by any information storage and retrieval system, without the prior written permission of Imperial Architecture.

Disclaimer  
Imperial Architecture is not responsible for the accuracy of the information provided in this document. The user assumes full responsibility for the use of the information.

NO.	DATE	DESCRIPTION	BY	CHKD.	DATE
1	08/16/19	ISSUED FOR REZONING	WJ	WJ	08/16/19
2	08/16/19	REVISION	WJ	WJ	08/16/19
3	08/16/19	REVISION	WJ	WJ	08/16/19
4	08/16/19	REVISION	WJ	WJ	08/16/19
5	08/16/19	REVISION	WJ	WJ	08/16/19
6	08/16/19	REVISION	WJ	WJ	08/16/19
7	08/16/19	REVISION	WJ	WJ	08/16/19
8	08/16/19	REVISION	WJ	WJ	08/16/19
9	08/16/19	REVISION	WJ	WJ	08/16/19
10	08/16/19	REVISION	WJ	WJ	08/16/19

ISSUED FOR REZONING  
RESUBMISSION  
(2019-08-16)

STEVESTON HWY TOWNHOUSE  
DEVELOPMENT ROK  
KONIG  
4711, 4591 & 4611 STEVESTON HWY,  
RICHMOND, BC V6X 1R9

COVER PAGE

Page No. #9217  
Sheet N.T.S.  
Date 16/08/2019

A 0.0 of 8



CNCL - 247

## TOWNHOUSE DEVELOPMENT (RZ 18-839945) 4571, 4591, 4611 STEVESTON HIGHWAY, RICHMOND, BC

ISSUED FOR REZONING RE-SUBMISSION 2019-08-16

### DRAWING LIST

ARCHITECTURAL:

- A0.0 COVER SHEET
- A0.1 COLOR RENDERING - FLY LEVEL STREETSCAPE VIEWS
- A0.2 COLOR RENDERING - BIRD-EYE VIEWS
- A0.3 PROJECT DATA & STATISTICS
- A0.4 SITE CONTEXT AERIAL IMAGE
- A0.5 SITE CONTEXT PLANNING STREETSCAPE ELEVATION
- A0.6 SITE SURVEY PLAN
- A1.1 SITE / LEVEL 1 PLAN
- A1.2 SITE PLAN
- A1.3 FIRE FIGHTING PLAN
- A1.4 PARKING PLAN
- A1.5 PRIVATE OUTDOOR ARE & OUTDOOR AMENITY AREA OVERLAY
- A1.6 SITE COVERAGE AREA OVERLAY (BUILDING & PORCH)
- A1.7 DEVELOPMENT POTENTIAL PLAN

- A2.1 BUILDING A FLOOR PLANS
- A2.2 BUILDING B FLOOR PLANS
- A2.3 BUILDING C, D, E FLOOR PLANS
- A3.1 CONTEXT / RUNNING ELEVATIONS
- A3.2 BUILDING A ELEVATIONS
- A3.3 BUILDING B ELEVATIONS
- A3.4 BUILDING C ELEVATIONS
- A3.5 BUILDING D & E ELEVATIONS
- A4.1 BUILDING SECTIONS
- A5.1 UNIT TYPE A AREA CALCULATION DIAGRAM
- A5.2 UNIT TYPE B PLANS
- A5.3 UNIT TYPE B AREA CALCULATION DIAGRAM

- A6.1 UNIT TYPE B AREA CALCULATION DIAGRAM
- A6.2 UNIT TYPE C AREA CALCULATION DIAGRAM
- A6.3 UNIT TYPE C AREA CALCULATION DIAGRAM
- A6.4 UNIT TYPE D AREA CALCULATION DIAGRAM
- A6.5 UNIT TYPE D AREA CALCULATION DIAGRAM
- A6.6 UNIT TYPE E AREA CALCULATION DIAGRAM
- A6.7 UNIT TYPE E AREA CALCULATION DIAGRAM
- A6.8 UNIT TYPE E AREA CALCULATION DIAGRAM
- A6.9 UNIT TYPE E AREA CALCULATION DIAGRAM
- A6.10 UNIT TYPE E AREA CALCULATION DIAGRAM
- A6.11 UNIT TYPE E AREA CALCULATION DIAGRAM
- A6.12 UNIT TYPE E AREA CALCULATION DIAGRAM
- A6.13 UNIT TYPE E AREA CALCULATION DIAGRAM
- A6.14 UNIT TYPE E AREA CALCULATION DIAGRAM
- A6.15 UNIT TYPE E AREA CALCULATION DIAGRAM
- A6.16 UNIT TYPE E AREA CALCULATION DIAGRAM
- A6.17 UNIT TYPE E AREA CALCULATION DIAGRAM

### CONTACT LIST

**DEVELOPER**  
KONIG DEVELOPMENT LTD.  
1138-1070 MAYFIELD PLACE  
RICHMOND, BC V6X 1R9  
CONTACT: KETH LEUNG, CEO  
PHONE: 604-285-5170, FAX: 604-285-5172  
EMAIL: KETH@KONIG.CA

**ARCHITECT**  
IMPERIAL ARCHITECTURE  
7750 FRANK STREET  
VANCOUVER, BC, V6P 4V5  
CONTACT: JANG ZHU, ARCHITECT ABC  
TEL: 778-836-8532  
EMAIL: IMPERIALARCHITECTURE@GMAIL.COM

**SURVEYOR**  
J.C. TAM & ASSOCIATES  
PROFESSIONAL LAND SURVEYORS  
11000 152ND STREET  
RICHMOND, BC V6V 3C8  
CONTACT: JOHNSON TAM, B.C.L.S.  
TEL: 604-214-8228  
EMAIL: OFFICE@JCTAM.COM

**ELECTRICAL**  
ELECTRICAL CONSULTING LTD.  
198-1121 HORSESHOE WAY, RICHMOND, BC V7A 3B7  
CONTACT: RICHARD V. LEW, P. ENG.  
TEL: 604-271-3157  
EMAIL: RLEW@ELECTLTD.COM

**LANDSCAPE**  
PING LANDSCAPE ARCHITECTS  
10000 152ND STREET  
RICHMOND, BC V6V 3C8  
CONTACT: MARY CHAN YIP, MCLSA | MCLSA  
TEL: 604-234-0011  
EMAIL: MARY@PINGLANDSCAPE.COM

**ARBORIST**  
A2L GROUP ARBORTECH CONSULTING  
145 - 12511 HORSESHOE WAY  
RICHMOND, BC V6V 3C8  
CONTACT: LAELIA OTTO, ARBORIST  
TEL: 604-413-5911  
P: 804-275-3484  
EMAIL: AELICIA@A2LGROUP.CA

**CIVIL**  
CORE CONCEPT CONSULTING LTD.  
CIVIL & MECHANICAL & SURVEY  
228-2623 VIKING WAY, RICHMOND, BC V7A 3B7  
CONTACT: BRUCE DUFFY, DIRECTOR  
TEL: 604-269-5064, FAX: 604-269-5061  
EMAIL: BRUCE@CORECONCEPTCONSULTING.COM

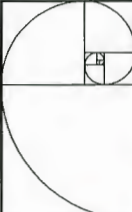

**IMPERIAL ARCHITECTURE**  
 BOARD OF ARCHITECTURE OF PRACTICE  
 4071 HWY 481 STEVENSON HWY.  
 BLOOMING, N.C. 28714-3945

ARCHITECTS  
 INTERIOR DESIGNERS  
 PLANNERS

Copyright Reserved  
 No part of this document may be reproduced or transmitted in any form or by any means, electronic or mechanical, including photocopying, recording, or by any information storage and retrieval system, without permission in writing from Imperial Architecture.

NO.	DATE	BY	REVISION
1	08/16/19	JK	ISSUED FOR REZONING RESUBMISSION
2	08/16/19	JK	ISSUED FOR REZONING RESUBMISSION
3	08/16/19	JK	ISSUED FOR REZONING RESUBMISSION
4	08/16/19	JK	ISSUED FOR REZONING RESUBMISSION
5	08/16/19	JK	ISSUED FOR REZONING RESUBMISSION
6	08/16/19	JK	ISSUED FOR REZONING RESUBMISSION
7	08/16/19	JK	ISSUED FOR REZONING RESUBMISSION
8	08/16/19	JK	ISSUED FOR REZONING RESUBMISSION
9	08/16/19	JK	ISSUED FOR REZONING RESUBMISSION
10	08/16/19	JK	ISSUED FOR REZONING RESUBMISSION

ISSUED FOR REZONING  
 RESUBMISSION  
 (2019-08-16)

STEVENSON HWY TOWNHOUSE  
 DEVELOPMENT FOR



4071 HWY 481 STEVENSON HWY.  
 BLOOMING, N.C. 28714-3945

COLOR RENDERING

Project No. #8217  
 Drawing No. A.0.1  
 Scale N.T.S.  
 Sheet 1 of 1



CNCL - 248



**IMPERIAL ARCHITECTURE**  
 HULLBERG BY AN LLC CERTIFICATE OF PRACTICE  
 1000 W. 10TH STREET, SUITE 100  
 DENVER, CO 80202  
 TEL: 303.733.1111  
 WWW.IMPERIALARCHITECTURE.COM

ARCHITECTURE  
 INTERIOR  
 PLANNING

Copyright © 2017 Imperial Architecture, LLC. All rights reserved. No part of this document may be reproduced, stored in a retrieval system, or transmitted in any form or by any means, electronic, mechanical, photocopying, recording, or by any information storage and retrieval system, without the prior written permission of Imperial Architecture, LLC. 10/17/17

NO.	DESCRIPTION	DATE	BY	CHKD.
1	ISSUED FOR REZONING RESUBMISSION (2019-08-16)			
2				
3				
4				
5				
6				
7				
8				
9				
10				

ISSUED FOR REZONING RESUBMISSION (2019-08-16)

OWNER: STEVESTON HWY TOWNHOUSE DEVELOPMENT FOR  
**JKONIG**  
 4571, 4571 & 4611 STEVESTON HWY.,  
 ROCKFORD, IL 61109

TITLE: SITE CONTEXT PLAN  
 STRESCAPE ELEVATION

Project No. #8217  
 Date: 11-20-07  
 Drawing: 1 of 1

**A.0.5**

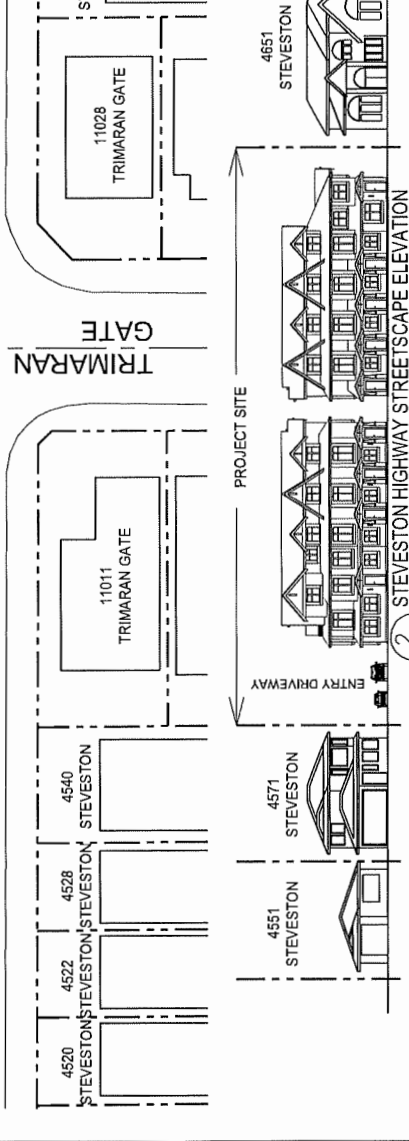
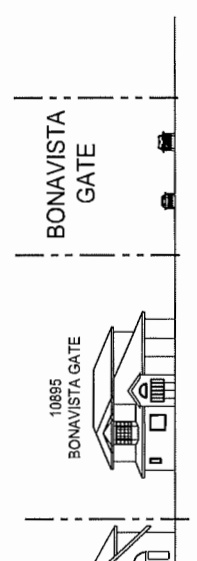
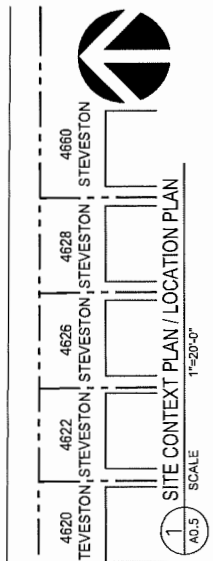
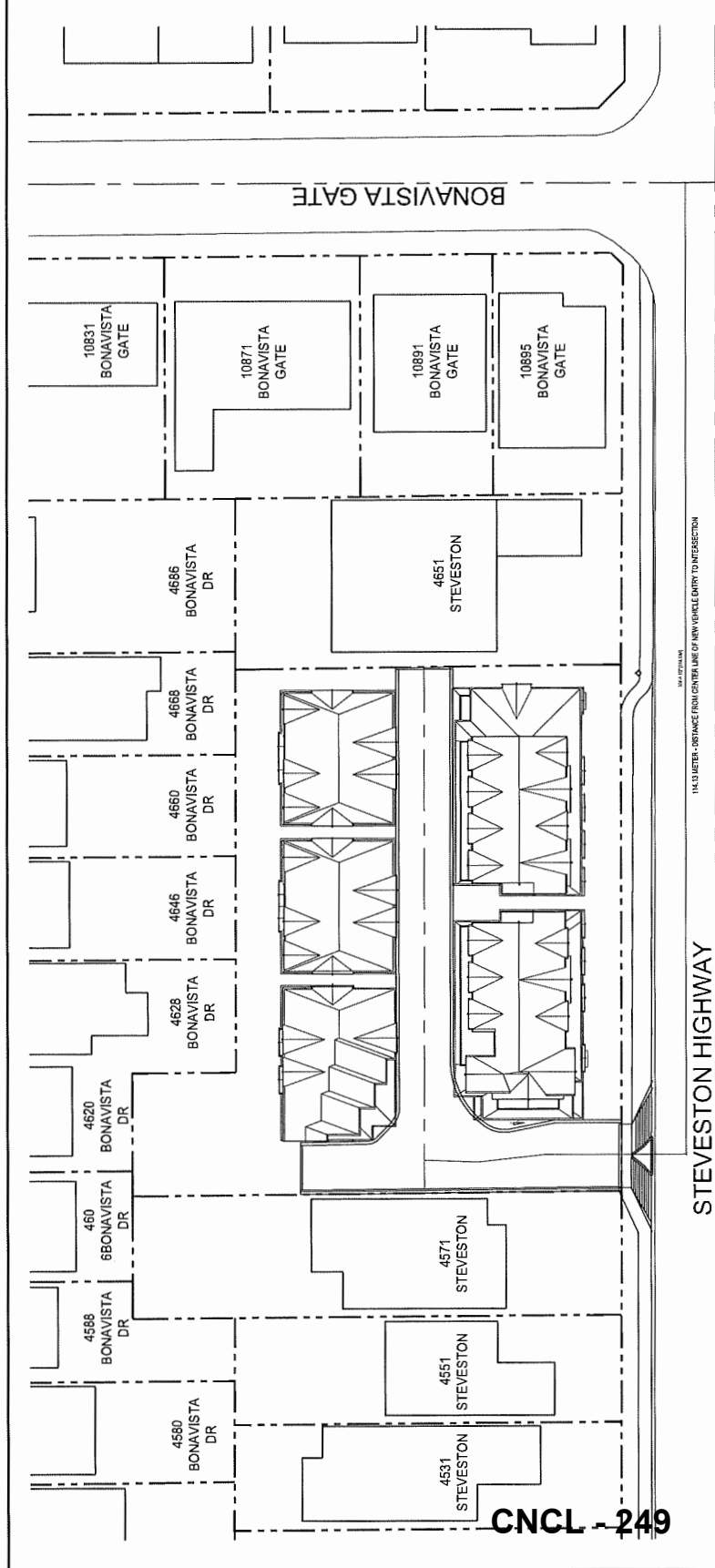

**CNCL - 249**

**IMPERIAL ARCHITECTURE**  
 HOLDERS OF AN ARCHITECTURE OF PRACTICE  
 4511 40th Ave. S Steveston Hwy.  
 Richmond, BC V6V 1K4 (604) 273-2222  
 www.imperialarch.com

ARCHITECTURE  
 INTERIOR  
 PLANNING

Copyright Reserved  
 No part of this document may be reproduced, stored in a retrieval system, or transmitted in any form or by any means, electronic, mechanical, photocopying, recording, or by any information storage and retrieval system, without the prior written permission of Imperial Architecture. All rights reserved.

Distribution  
 This document is the property of Imperial Architecture. It is to be used only for the project and site identified herein. It is not to be distributed, copied, or otherwise used for any other project or site without the prior written permission of Imperial Architecture. All rights reserved.

NO.	REVISION	DATE	BY	CHKD.
1	ISSUED FOR REZONING RESUBMISSION (2019-08-16)			
2				
3				
4				
5				
6				
7				
8				
9				
10				

ISSUED FOR REZONING  
 RESUBMISSION  
 (2019-08-16)

Client: STEVESTON HWY. TOWNHOUSE DEVELOPMENT FOR

Project: 4511 40th Ave. S Steveston Hwy. RICHMOND, BC (V6V 1K4) (604) 273-2222

Site / LEVEL 1 FLOOR PLAN

Scale: 3/32"=1'-0"

Sheet: A.1.1

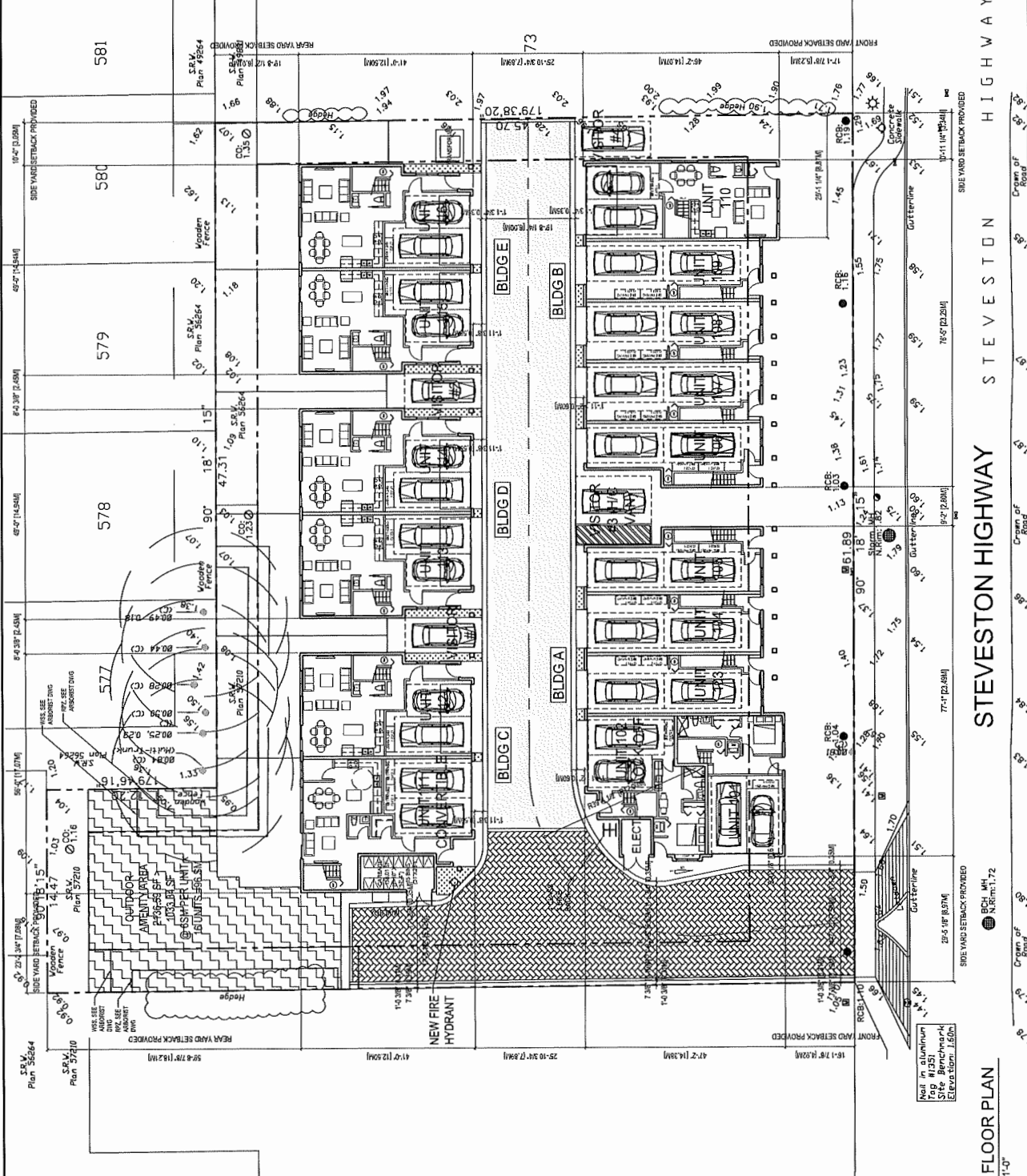

REAR YARD SETBACK PROVIDED  
 SIDE YARD SETBACK PROVIDED  
 FRONT YARD SETBACK PROVIDED

STEVESTON HIGHWAY

Scale: 3/32"=1'-0"

Sheet: A.1.1

- GENERAL NOTES:
1. WORK IN PLACE FEATURES SUCH AS CONCRETE WALLS TO REMAIN SHALL BE MAINTAINED AND PROTECTED. CRACK REPAIR SHALL BE PROVIDED TO MATCH EXISTING. FINISHES SHALL BE PROVIDED TO MATCH EXISTING. ALL WORK SHALL BE DONE IN ACCORDANCE WITH THE BC BUILDING ACT AND REGULATIONS. FOLLOWING SUSTAINABLE DESIGN REQUIREMENTS SHALL BE PROVIDED IN THE PROJECT: 1. ENERGY EFFICIENT LIGHTING: ALL LIGHT FIXTURES SHALL BE ENERGY EFFICIENT AND PROVIDE APPROPRIATE ILLUMINATION. 2. WATER SAVING TOILETS AND SINKS: ALL TOILETS AND SINKS SHALL BE WATER SAVING AND PROVIDE APPROPRIATE PERFORMANCE. 3. ENERGY EFFICIENT WINDOWS: ALL WINDOWS SHALL BE ENERGY EFFICIENT AND PROVIDE APPROPRIATE PERFORMANCE. 4. ENERGY EFFICIENT DOORS: ALL DOORS SHALL BE ENERGY EFFICIENT AND PROVIDE APPROPRIATE PERFORMANCE. 5. ENERGY EFFICIENT ROOFING: ALL ROOFING SHALL BE ENERGY EFFICIENT AND PROVIDE APPROPRIATE PERFORMANCE. 6. ENERGY EFFICIENT FLOORING: ALL FLOORING SHALL BE ENERGY EFFICIENT AND PROVIDE APPROPRIATE PERFORMANCE. 7. ENERGY EFFICIENT PAINTS AND COATINGS: ALL PAINTS AND COATINGS SHALL BE ENERGY EFFICIENT AND PROVIDE APPROPRIATE PERFORMANCE. 8. ENERGY EFFICIENT GLAZING: ALL GLAZING SHALL BE ENERGY EFFICIENT AND PROVIDE APPROPRIATE PERFORMANCE. 9. ENERGY EFFICIENT MECHANICAL SYSTEMS: ALL MECHANICAL SYSTEMS SHALL BE ENERGY EFFICIENT AND PROVIDE APPROPRIATE PERFORMANCE. 10. ENERGY EFFICIENT ELECTRICAL SYSTEMS: ALL ELECTRICAL SYSTEMS SHALL BE ENERGY EFFICIENT AND PROVIDE APPROPRIATE PERFORMANCE.
  2. UNIT 11 (TYPE C) IS THE CONVERTIBLE UNIT.
  3. UNIT 102 (TYPE A) IS THE LOCK-OFF UNIT.
  4. THE PROJECT WILL PROVIDE AIR SOURCE HEAT PUMP UNIT WITH VRF MECHANICAL SYSTEMS TO SERVE ALL UNITS. THE REQUIREMENTS WILL ALSO BE PROVIDED IN THE PROJECT: 1. ENERGY EFFICIENT LIGHTING: ALL LIGHT FIXTURES SHALL BE ENERGY EFFICIENT AND PROVIDE APPROPRIATE ILLUMINATION. 2. WATER SAVING TOILETS AND SINKS: ALL TOILETS AND SINKS SHALL BE WATER SAVING AND PROVIDE APPROPRIATE PERFORMANCE. 3. ENERGY EFFICIENT WINDOWS: ALL WINDOWS SHALL BE ENERGY EFFICIENT AND PROVIDE APPROPRIATE PERFORMANCE. 4. ENERGY EFFICIENT DOORS: ALL DOORS SHALL BE ENERGY EFFICIENT AND PROVIDE APPROPRIATE PERFORMANCE. 5. ENERGY EFFICIENT ROOFING: ALL ROOFING SHALL BE ENERGY EFFICIENT AND PROVIDE APPROPRIATE PERFORMANCE. 6. ENERGY EFFICIENT FLOORING: ALL FLOORING SHALL BE ENERGY EFFICIENT AND PROVIDE APPROPRIATE PERFORMANCE. 7. ENERGY EFFICIENT PAINTS AND COATINGS: ALL PAINTS AND COATINGS SHALL BE ENERGY EFFICIENT AND PROVIDE APPROPRIATE PERFORMANCE. 8. ENERGY EFFICIENT GLAZING: ALL GLAZING SHALL BE ENERGY EFFICIENT AND PROVIDE APPROPRIATE PERFORMANCE. 9. ENERGY EFFICIENT MECHANICAL SYSTEMS: ALL MECHANICAL SYSTEMS SHALL BE ENERGY EFFICIENT AND PROVIDE APPROPRIATE PERFORMANCE. 10. ENERGY EFFICIENT ELECTRICAL SYSTEMS: ALL ELECTRICAL SYSTEMS SHALL BE ENERGY EFFICIENT AND PROVIDE APPROPRIATE PERFORMANCE.
  5. ALL MECHANICAL SYSTEMS AND EQUIPMENT SHALL BE ENERGY EFFICIENT AND PROVIDE APPROPRIATE PERFORMANCE. 6. ALL ELECTRICAL SYSTEMS SHALL BE ENERGY EFFICIENT AND PROVIDE APPROPRIATE PERFORMANCE. 7. ALL PLUMBING SYSTEMS SHALL BE ENERGY EFFICIENT AND PROVIDE APPROPRIATE PERFORMANCE. 8. ALL ROOFING SYSTEMS SHALL BE ENERGY EFFICIENT AND PROVIDE APPROPRIATE PERFORMANCE. 9. ALL FLOORING SYSTEMS SHALL BE ENERGY EFFICIENT AND PROVIDE APPROPRIATE PERFORMANCE. 10. ALL PAINTS AND COATINGS SHALL BE ENERGY EFFICIENT AND PROVIDE APPROPRIATE PERFORMANCE.
  6. AN AUTOMATED BRIGATION SYSTEM FOR FUTURE ONGOING MAINTENANCE WILL BE INSTALLED. SEE LANDSCAPE.

STEVESTON HIGHWAY

Scale: 3/32"=1'-0"

Sheet: A.1.1

1 SITE / LEVEL 1 FLOOR PLAN

Scale: 3/32"=1'-0"

Sheet: A.1.1

Imperial Architecture logo and contact information



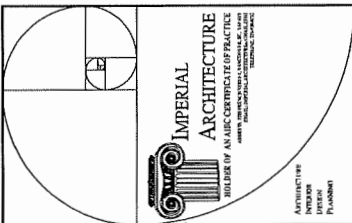

**IMPERIAL ARCHITECTURE**  
 ARCHITECTS  
 1000 W. 10TH AVENUE, SUITE 100  
 DENVER, CO 80202  
 TEL: 303.733.8800  
 WWW.IMPERIALARCHITECTURE.COM

**Copyright Reserved**  
 No part of this document may be reproduced, stored in a retrieval system, or transmitted in any form or by any means, electronic, mechanical, photocopying, recording, or by any information storage and retrieval system, without the prior written permission of Imperial Architecture.

**Disclaimer**  
 This document is prepared for the use of the client and is not to be used for any other purpose without the prior written permission of Imperial Architecture.

NO.	DATE	DESCRIPTION	BY	CHKD.	APP.
1	08/15/19	ISSUED FOR REZONING RESUBMISSION	AS	AS	AS
2	08/15/19	ISSUED FOR REZONING RESUBMISSION	AS	AS	AS
3	08/15/19	ISSUED FOR REZONING RESUBMISSION	AS	AS	AS
4	08/15/19	ISSUED FOR REZONING RESUBMISSION	AS	AS	AS
5	08/15/19	ISSUED FOR REZONING RESUBMISSION	AS	AS	AS
6	08/15/19	ISSUED FOR REZONING RESUBMISSION	AS	AS	AS
7	08/15/19	ISSUED FOR REZONING RESUBMISSION	AS	AS	AS
8	08/15/19	ISSUED FOR REZONING RESUBMISSION	AS	AS	AS
9	08/15/19	ISSUED FOR REZONING RESUBMISSION	AS	AS	AS
10	08/15/19	ISSUED FOR REZONING RESUBMISSION	AS	AS	AS

**ISSUED FOR REZONING RESUBMISSION**  
 (2019-08-16)

STEVESTON HWY TOWNHOUSE DEVELOPMENT FOR

**KONIG ATTORNEYS**  
 6711 40TH AVENUE, SUITE 100  
 RICHMOND, CO 80441

**BUILDING A FLOOR PLANS**

Project: #82177  
 Scale: 1/8"=1'-0"  
 Sheet: A2.1

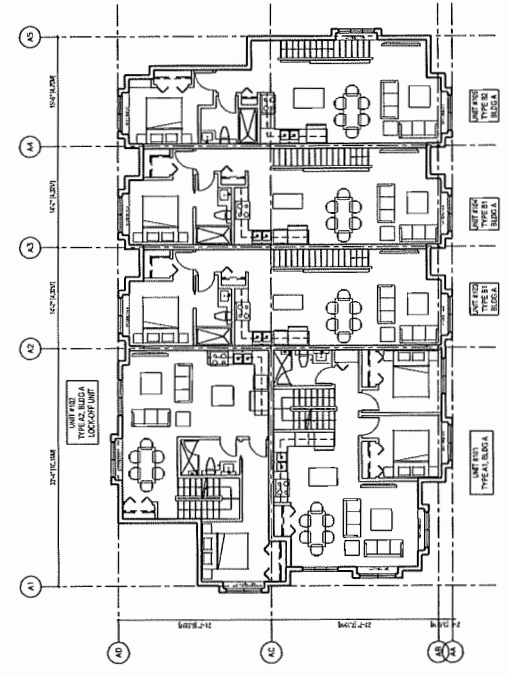

**2 BUILDING A LEVEL 2 FLOOR PLAN**  
 SCALE 1/8"=1'-0"  
 A2.1

**GENERAL NOTES:**

- AGING IN PLACE FEATURES SUCH AS "STAIRWELL HANDRAILS, SOLID BLOCKING IN WASHROOM WALLS TO FACILITATE FUTURE GRAB BAR INSTALLATION BESIDE TOILET, BATH TUB AND SHOWER" AND "LEVER-TYPE HANDLES FOR PLUMBING FIXTURES AND DOOR HANDLES" WILL BE PROVIDED IN ALL UNITS.
- UNIT 111 (TYPE C1) IS THE CONVERTIBLE UNIT.
- UNIT 102 (TYPE A2) IS THE LOCK-OFF UNIT.
- THE PROJECT WILL PROVIDE AIR SOURCE HEAT PUMP A/C UNIT WITH HRV MECHANICAL VENTILATION SYSTEM TO ACHIEVE STEP CODE REQUIREMENTS. FOLLOWING SUSTAINABLE FEATURES WILL ALSO BE PROVIDED IN THE PROJECT:  
 (A) SOLAR HOT WATER READY REQUIREMENT BULBS  
 (B) ENERGY STAR APPLIANCES AND LIGHT BULBS  
 (C) LOW E DOUBLE GLAZING WINDOWS  
 (D) POWER OUTLET IN PRIVATE GARAGE FOR CHARGING ELECTRIC CARS
- THE MECHANICAL HEATING AND COOLING SYSTEM (AIR SOURCE HEAT PUMP SYSTEM) TO COMPLY WITH RELATIVE REQUIREMENTS IN CBC-C 2018 AND ASHRAE 55 REGARDING THE STANDARDS OF THERMAL COMFORT.
- AN AUTOMATED IRRIGATION SYSTEM FOR FUTURE ON-GOING MAINTENANCE WILL BE INSTALLED. SEE LANDSCAPE

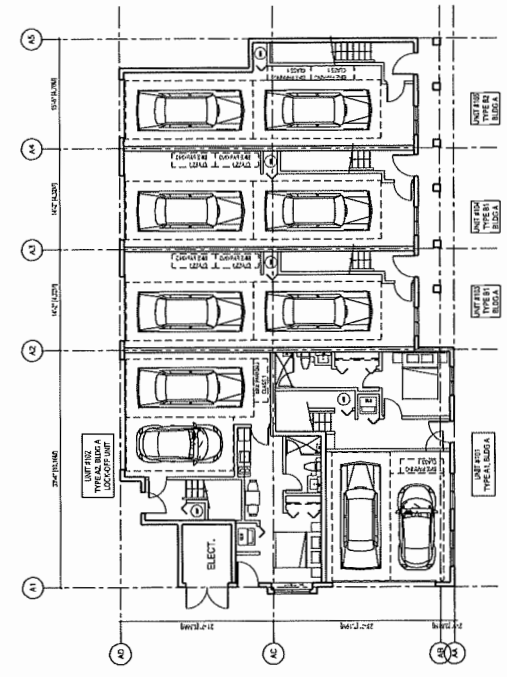

**1 BUILDING A LEVEL 1 FLOOR PLAN**  
 SCALE 1/8"=1'-0"  
 A2.1

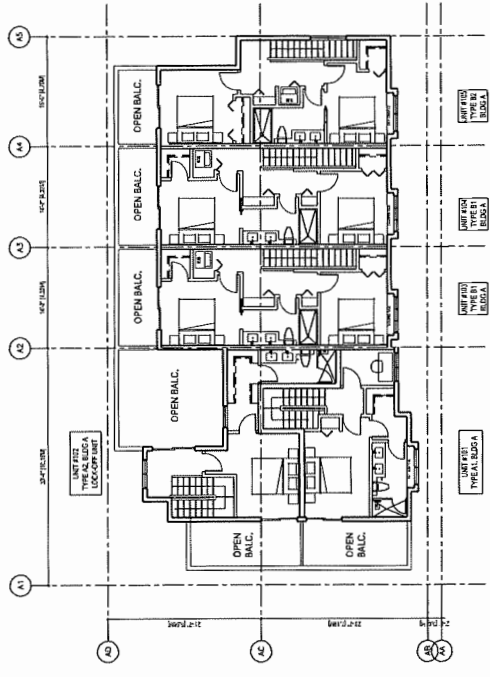

**3 BUILDING A LEVEL 3 FLOOR PLAN**  
 SCALE 1/8"=1'-0"  
 A2.1

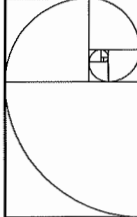

**IMPERIAL ARCHITECTURE**  
 ARCHITECTS  
 400 WEST 10TH AVENUE, SUITE 100  
 DENVER, CO 80202  
 (303) 733-1111  
 WWW.IMPERIALARCHITECTURE.COM

Copyright Imperial  
 Architecture  
 No part of this document may be reproduced, stored in a retrieval system, or transmitted in any form or by any means, electronic, mechanical, photocopying, recording, or by any information storage and retrieval system, without the prior written permission of Imperial Architecture.

Imperial Architecture is an Equal Opportunity Employer. Minorities and women are encouraged to apply.  
 Imperial Architecture is an Equal Opportunity Employer. Minorities and women are encouraged to apply.

NO.	REVISION	DATE	BY	CHKD.
1	ISSUED FOR REZONING RESUBMISSION (2019-08-16)			

ISSUED FOR REZONING  
 RESUBMISSION  
 (2019-08-16)

317 WESTON HWY TOWNHOUSE  
 DEVELOPMENT FOR  
**KONIG**  
 4571 40TH AVE E, SUITE 100  
 DENVER, CO 80231

**BUILDING B FLOOR PLANS**  
 Project No. #8217  
 Scale 1/8"=1'-0"  
 Sheet A.2.2 of 2

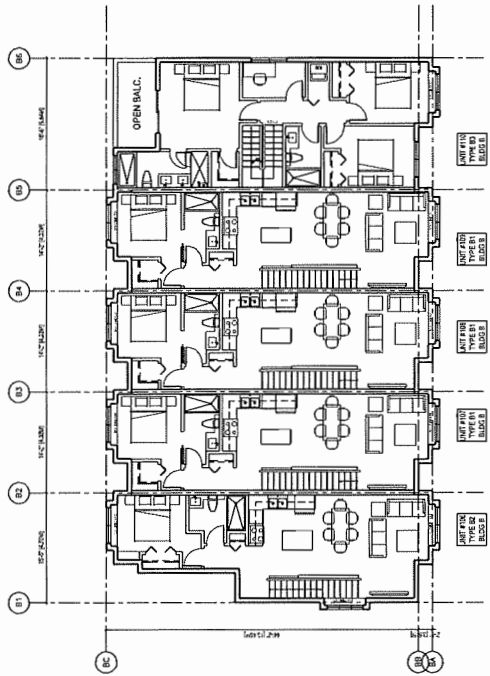

**2 BUILDING B LEVEL 2 FLOOR PLAN**  
 SCALE 1/8"=1'-0"  
 A2.2

**GENERAL NOTES:**

- AGING IN PLACE FEATURES SUCH AS STAIRWELL HANDRAILS, SOLID BLOCKING IN WASHROOM WALLS TO FACILITATE FUTURE GRAB BAR INSTALLATION BESIDE TOILET, BATH TUB AND SHOWER AND LEVER-TYPE HANDLES FOR PLUMBING FIXTURES AND DOOR HANDLES WILL BE PROVIDED IN ALL UNITS.
- UNIT 111 (TYPE C1) IS THE CONVERTIBLE UNIT.
- UNIT 102 (TYPE A2) IS THE LOCK-OFF UNIT.
- THE PROJECT WILL PROVIDE AIR SOURCE HEAT PUMP AC UNIT WITH HRY MECHANICAL VENTILATION SYSTEM TO ACHIEVE STEP CODE REQUIREMENTS. FOLLOWING SUSTAINABLE FEATURES WILL ALSO BE PROVIDED IN THE PROJECT:  
 (A) SOLAR HOT WATER READY REQUIREMENT  
 (B) ENERGY STAR APPLIANCES AND LIGHT BULBS  
 (C) LOW E DOUBLE GLAZING WINDOWS  
 (D) POWER OUTLET IN PRIVATE GARAGE FOR CHARGING ELECTRIC CARS
- THE MECHANICAL HEATING AND COOLING SYSTEM (AIR SOURCE HEAT PUMP SYSTEM) TO COMPLY WITH RELATIVE REQUIREMENTS IN CBC 2018 AND ASHRAE 55 REGARDING THE STANDARDS OF THERMAL COMFORT.
- AN AUTOMATED IRRIGATION SYSTEM FOR FUTURE ON-GOING MAINTENANCE WILL BE INSTALLED. SEE LANDSCAPE

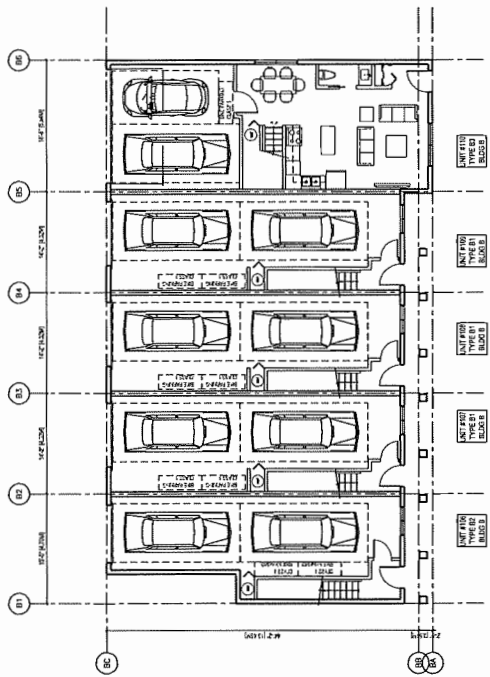

**1 BUILDING B LEVEL 1 FLOOR PLAN**  
 SCALE 1/8"=1'-0"  
 A2.2

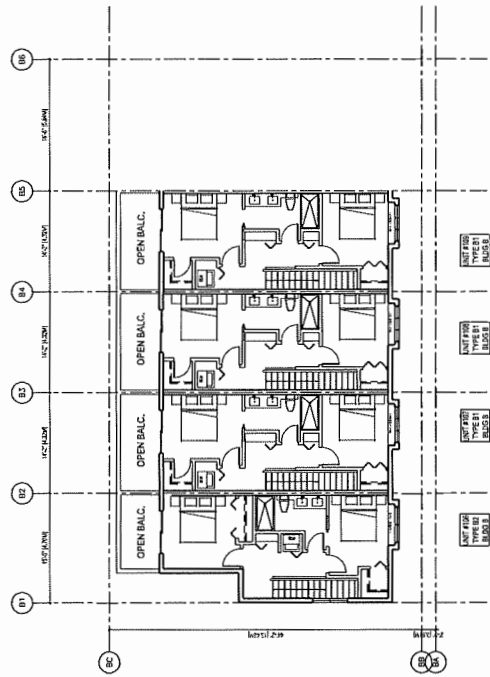

**3 BUILDING B LEVEL 3 FLOOR PLAN**  
 SCALE 1/8"=1'-0"  
 A2.2

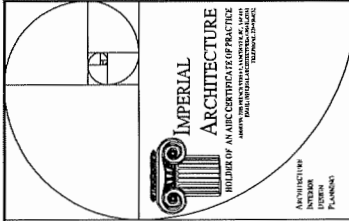

**IMPERIAL ARCHITECTURE**  
 ARCHITECTS OF RECORD  
 4071 40th AVE STEVENSON HWY  
 RICHMOND, BC V6X 2A9

ARCHITECTIVE  
 INTERIOR  
 PLUMBING

Copyright Reserved

All rights reserved. No part of this publication may be reproduced, stored in a retrieval system, or transmitted, in any form or by any means, electronic, mechanical, photocopying, recording, or by any information storage and retrieval system, without the prior written permission of Imperial Architecture.

NO.	DESCRIPTION	DATE	BY	APP.
1	ISSUED FOR REZONING	2019-08-16	AS	AS
2	REVISION			
3	REVISION			
4	REVISION			
5	REVISION			
6	REVISION			
7	REVISION			
8	REVISION			
9	REVISION			
10	REVISION			

ISSUED FOR REZONING  
 RESUBMISSION  
 (2019-08-16)

CLIENT:  
 STEVENSON HWY TOWNHOUSE  
 DEVELOPMENT FOR

**IMPERIAL ARCHITECTURE**  
 4071 40th AVE STEVENSON HWY  
 RICHMOND, BC V6X 2A9

PROJECT NO.  
 #8217

DATE  
 1/8"=1'-0"

SHEET  
 A 2.3

**GENERAL NOTES:**

- AGING IN PLACE FEATURES SUCH AS "STAIRWELL HANDRAILS, SOLID BLOCKING IN WASHROOM WALLS TO FACILITATE FUTURE GRAB BAR INSTALLATION BESIDE TOILET, BATHTUB AND SHOWER" AND "LEVER-TYPE HANDLES FOR PLUMBING FIXTURES AND DOOR HANDLES" WILL BE PROVIDED IN ALL UNITS.
- UNIT 111 (TYPE C1) IS THE CONVERTIBLE UNIT.
- UNIT 102 (TYPE A2) IS THE LOCK-OFF UNIT.
- THE PROJECT WILL PROVIDE AIR SOURCE HEAT PUMP A/C UNIT WITH HRV MECHANICAL VENTILATION SYSTEM TO ACHIEVE STEP CODE REQUIREMENTS. FOLLOWING SUSTAINABLE FEATURES WILL ALSO BE PROVIDED IN THE PROJECT:  
 (A) SOLAR HOT WATER READY REQUIREMENT BULBS  
 (B) ENERGY STAR APPLIANCES AND LIGHT BULBS  
 (C) LOW E DOUBLE GLAZING WINDOWS  
 (D) POWER OUTLET IN PRIVATE GARAGE FOR CHARGING ELECTRIC CARS  
 (E) THE MECHANICAL HEATING AND COOLING SYSTEM AIR SOURCE HEAT PUMP SYSTEM TO COMPLY WITH RELATIVE REQUIREMENTS IN BCBC-2018 AND ASHRAE 55 REGARDING THE STANDARDS OF THERMAL COMFORT.
- AN AUTOMATED IRRIGATION SYSTEM FOR FUTURE ON-GOING MAINTENANCE WILL BE INSTALLED. SEE LANDSCAPE

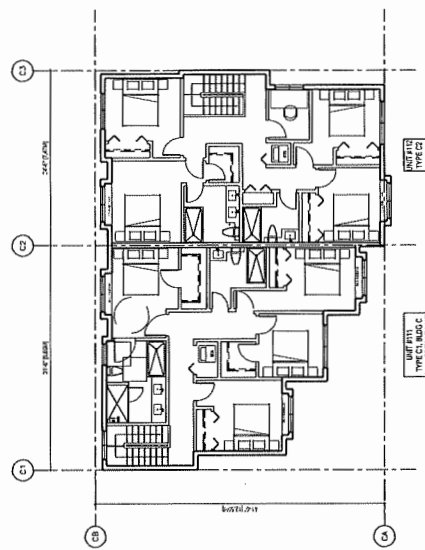

2. BUILDING C LEVEL 2 FLOOR PLAN  
 SCALE 1/8"=1'-0"

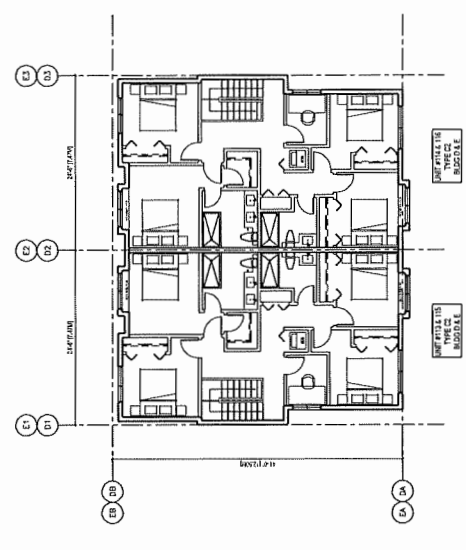

4. BUILDING D & E LEVEL 2 FLOOR PLAN  
 SCALE 1/8"=1'-0"

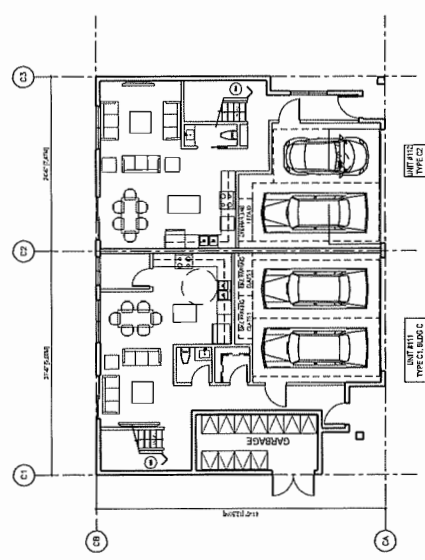

1. BUILDING C LEVEL 1 FLOOR PLAN  
 SCALE 1/8"=1'-0"

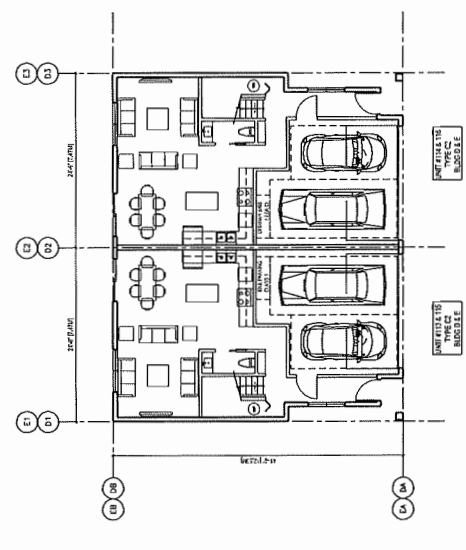

3. BUILDING D & E LEVEL 1 FLOOR PLAN  
 SCALE 1/8"=1'-0"

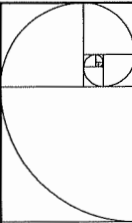

**IMPERIAL ARCHITECTURE**  
 A DIVISION OF AN ARCHITECTURE OF PRACTICE  
 4571 40th Ave, STE 100, STEVENSON LANE, CA 94394  
 TEL: (925) 391-1100 FAX: (925) 391-1101  
 WWW: WWW.IMPERIALARCHITECTURE.COM

Architects  
 Interior Designer  
 Planners

Copyright Reserved  
 All rights reserved. No part of this publication may be reproduced, stored in a retrieval system, or transmitted, in any form or by any means, electronic, mechanical, photocopying, recording, or by any information storage and retrieval system, without the prior written permission of the publisher.

Director/Designer: \_\_\_\_\_  
 Project Manager: \_\_\_\_\_  
 Date: \_\_\_\_\_

NO. OF SHEETS	12
NO. OF SHEETS USED	12
NO. OF SHEETS CHECKED	12
NO. OF SHEETS APPROVED	12
NO. OF SHEETS REVISIONS	0
NO. OF SHEETS CANCELLED	0
NO. OF SHEETS DELETED	0
NO. OF SHEETS ADDED	0
NO. OF SHEETS TOTAL	12

ISSUED FOR REZONING RESUBMISSION (2019-08-16)

STEVENSON LANE TOWNHOUSE DEVELOPMENT FOR

**KONIG**  
 ARCHITECTS  
 4571 40th Ave, STE 100, STEVENSON LANE, CA 94394  
 TEL: (925) 391-1100 FAX: (925) 391-1101  
 WWW: WWW.KONIGARCHITECTS.COM

Project No. #8217  
 Scale 1/16"=1'-0"  
 Drawing No. \_\_\_\_\_  
 Sheet \_\_\_\_\_

CONTEXT / RUNNING ELEVATIONS

**A 3.1**

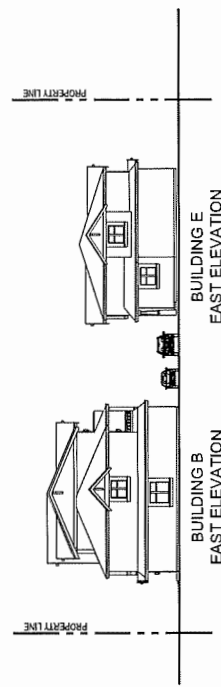
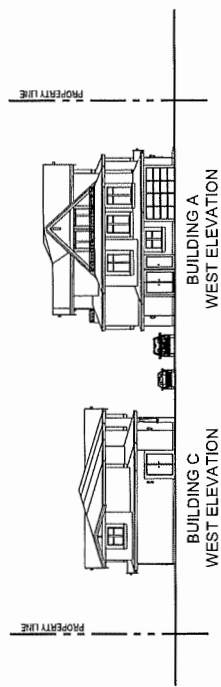
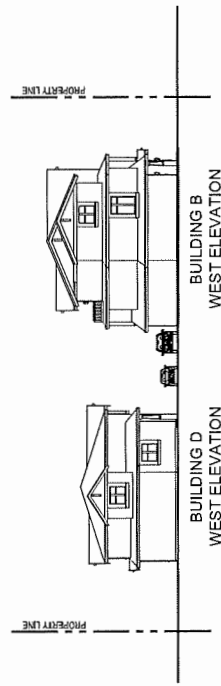
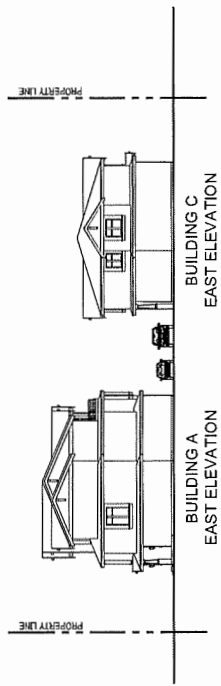

CNCL - 255

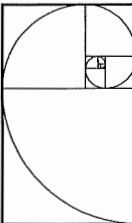

**IMPERIAL ARCHITECTURE**  
 A MEMBER OF AN ARCHITECTURE OF PRACTICE  
 4011 STEVENSON HWY. SUITE 100  
 RICHMOND, BC V6X 2K6  
 TEL: 604.273.8888  
 WWW.IMPERIALARCHITECTURE.COM

Copyright Reserved  
 No part of this drawing may be reproduced, stored in a retrieval system, or transmitted in any form or by any means, electronic, mechanical, photocopying, recording, or by any information storage and retrieval system, without the prior written permission of Imperial Architecture.

Drawings  
 1. GENERAL NOTES  
 2. EXTERIOR ELEVATIONS  
 3. INTERIOR ELEVATIONS  
 4. SECTION  
 5. FOUNDATION  
 6. ROOF PLAN  
 7. FLOOR PLAN  
 8. SITE PLAN

NO.	DATE	DESCRIPTION
1	2019-08-16	ISSUED FOR REZONING RESUBMISSION
2	2019-08-16	ISSUED FOR REZONING RESUBMISSION
3	2019-08-16	ISSUED FOR REZONING RESUBMISSION
4	2019-08-16	ISSUED FOR REZONING RESUBMISSION
5	2019-08-16	ISSUED FOR REZONING RESUBMISSION
6	2019-08-16	ISSUED FOR REZONING RESUBMISSION
7	2019-08-16	ISSUED FOR REZONING RESUBMISSION
8	2019-08-16	ISSUED FOR REZONING RESUBMISSION
9	2019-08-16	ISSUED FOR REZONING RESUBMISSION
10	2019-08-16	ISSUED FOR REZONING RESUBMISSION

ISSUED FOR REZONING  
 RESUBMISSION  
 (2019-08-16)

Client: STEVENSON HWY TOWNHOUSE  
 DEVELOPMENT FOR  
 KIMIC  
 4011 STEVENSON HWY.  
 RICHMOND, BC V6X 2K6

Project: #8217  
 Scale: 1/8"=1'-0"  
 Date: 2019-08-16

A3.2

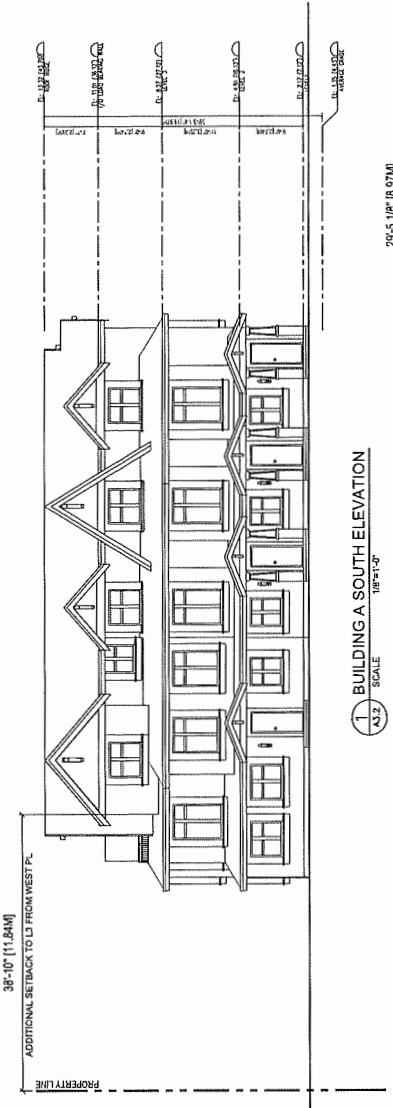

38'-10" [11.84M]

1 BUILDING A SOUTH ELEVATION  
 SCALE 1/8"=1'-0"

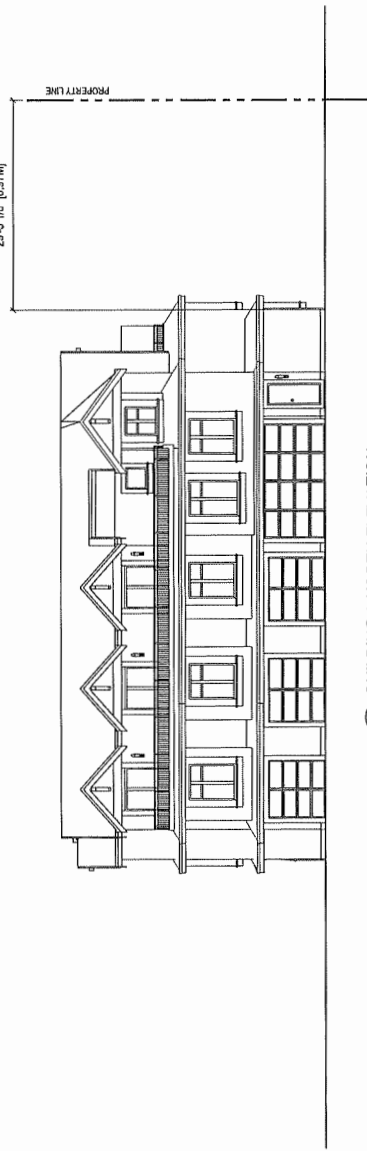

29'-5 1/8" [8.97M]

2 BUILDING A NORTH ELEVATION  
 SCALE 1/8"=1'-0"

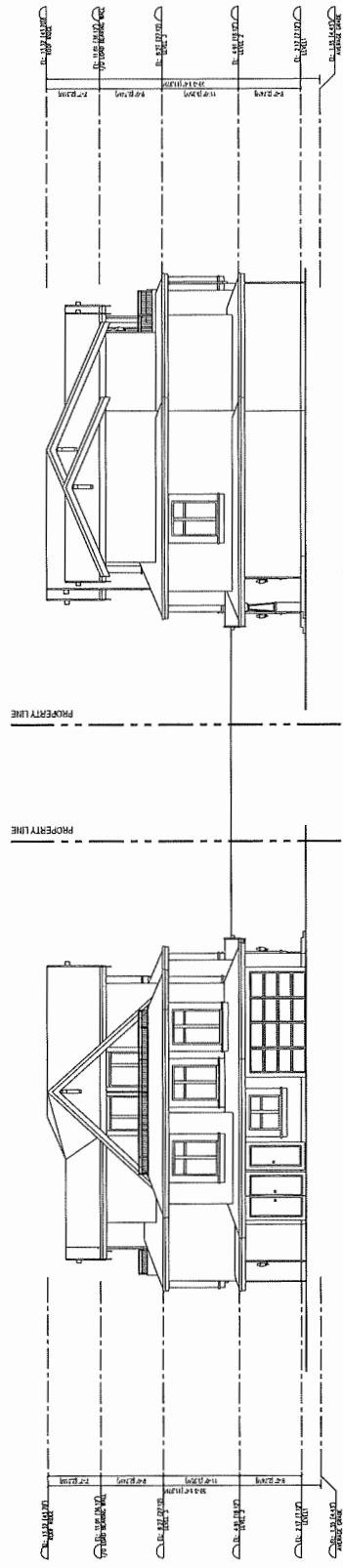

3 BUILDING A WEST ELEVATION  
 SCALE 1/8"=1'-0"

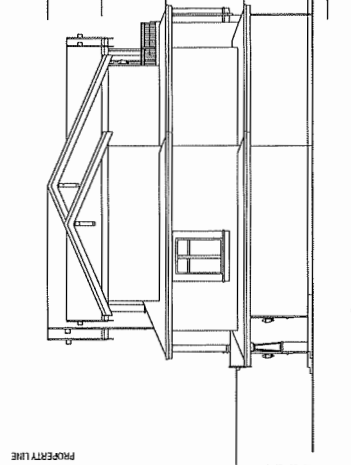

4 BUILDING A EAST ELEVATION  
 SCALE 1/8"=1'-0"



**IMPERIAL ARCHITECTURE**  
 ARCHITECTURE INTERIOR PLANNING  
 4500 W. 10TH AVE. SUITE 100  
 DENVER, CO 80202  
 TEL: 303.733.1111  
 WWW.IMPERIALARCHITECTURE.COM

**Copyright Reserved**  
 This drawing is the property of Imperial Architecture and shall not be used, copied, or reproduced in any form without the written consent of Imperial Architecture.

**Distribution**  
 This drawing is to be used only for the project and site indicated. It is not to be used for any other project or site without the written consent of Imperial Architecture.

PROJECT NO.	2019-08-16
DATE	08/16/19
SCALE	1/8" = 1'-0"
DATE	08/16/19
SCALE	1/8" = 1'-0"
DATE	08/16/19
SCALE	1/8" = 1'-0"
DATE	08/16/19
SCALE	1/8" = 1'-0"

**ISSUED FOR REZONING RESUBMISSION (2019-08-16)**

CLIENT: STEVENSON HUNY TOWNHOUSE DEVELOPMENT FOR

1 | **KONIG** ARCHITECTS  
 4511 4TH AVE. #400 STEVENSON HWY.  
 KENNESAW, WA 98143

**BUILDING B ELEVATIONS**

Project No. #8217  
 Date 1/8"=1'-0"  
 Drawing No. A.3.3

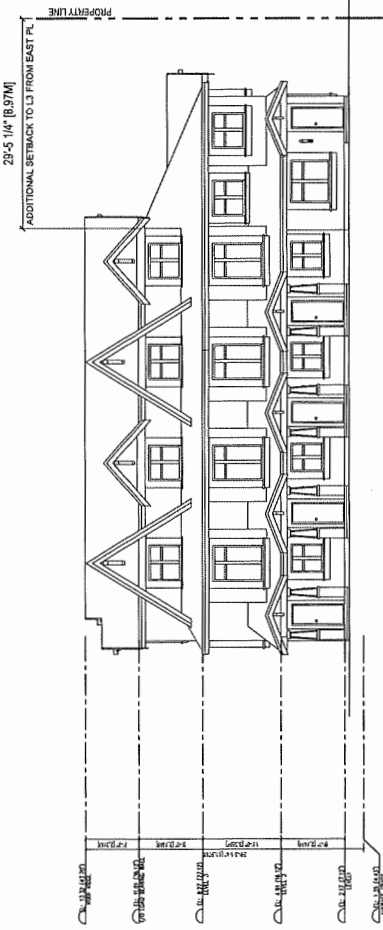

1. BUILDING B SOUTH ELEVATION  
 SCALE 1/8"=1'-0"  
 A.3.3

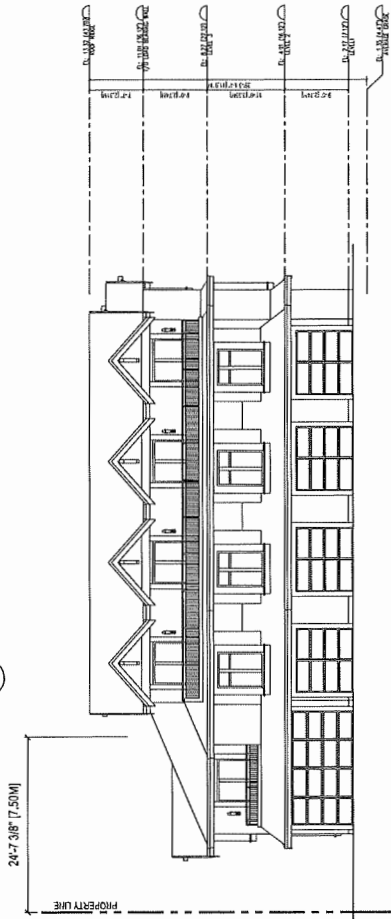

2. BUILDING B NORTH ELEVATION  
 SCALE 1/8"=1'-0"  
 A.3.3

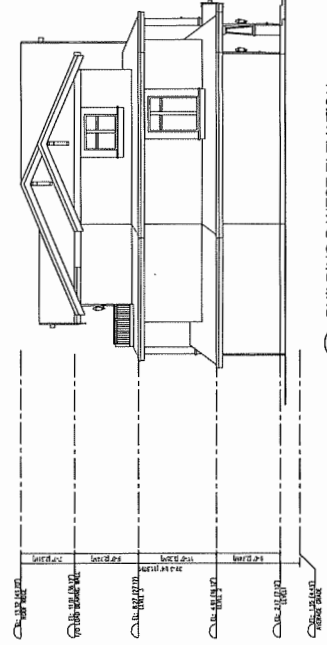

3. BUILDING B WEST ELEVATION  
 SCALE 1/8"=1'-0"  
 A.3.3

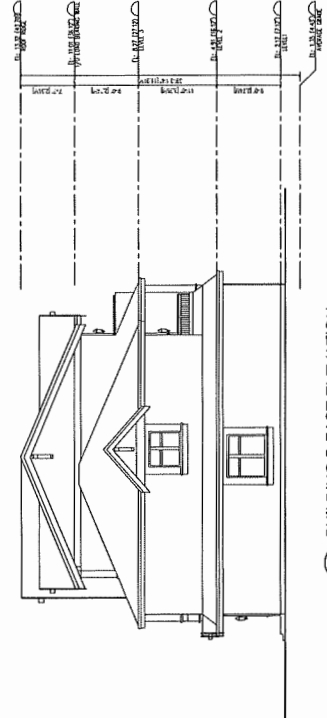

4. BUILDING B EAST ELEVATION  
 SCALE 1/8"=1'-0"  
 A.3.3

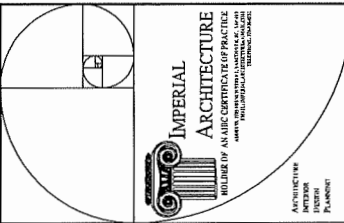

**IMPERIAL ARCHITECTURE**  
 ARCHITECTURE  
 BUILDER OF AN ARCHITECTURE OF PRACTICE  
 4011 40th St. #441 Stevenson Hwy.  
 Richmond, BC V6V 2G9  
 TEL: 604.273.8888  
 WWW.IMPERIALARCHITECTURE.COM

Architectural  
 Interior  
 Planning

Copyright Reserved  
 No part of this drawing may be reproduced, stored in a retrieval system, or transmitted in any form or by any means, electronic, mechanical, photocopying, recording, or by any information storage and retrieval system, without the prior written permission of Imperial Architecture.

Disclaimer  
 This drawing is for informational purposes only and does not constitute a contract. It is subject to change without notice. The client is responsible for obtaining all necessary permits and approvals from the appropriate authorities.

NO.	REVISION	DATE	BY	APP.
1	ISSUED FOR REZONING RESUBMISSION	2019-08-16		

ISSUED FOR REZONING RESUBMISSION (2019-08-16)

Classification: STEVENSON HWY. TOWNHOUSE DEVELOPMENT FOR

**IMPERIAL ARCHITECTURE**  
 4011 40th St. #441 Stevenson Hwy.  
 Richmond, BC V6V 2G9

Project No. #8217  
 Drawing No. **A 3.4**

Scale: 1/8"=1'-0"  
 Sheet: 8 of 8

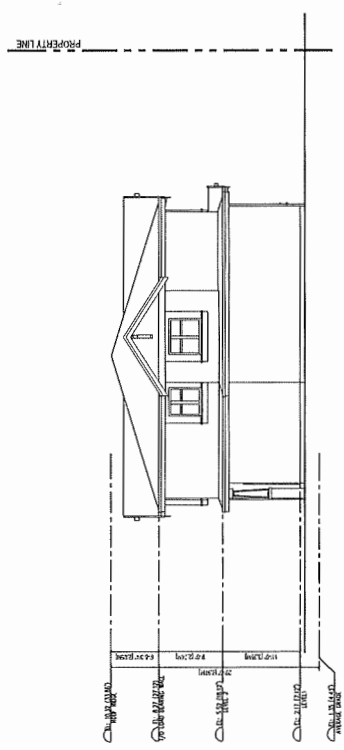

3. BUILDING C EAST ELEVATION  
 SCALE: 1/8"=1'-0"

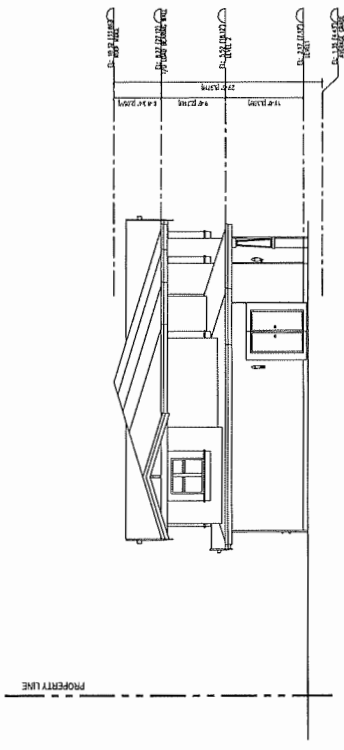

4. BUILDING C WEST ELEVATION  
 SCALE: 1/8"=1'-0"

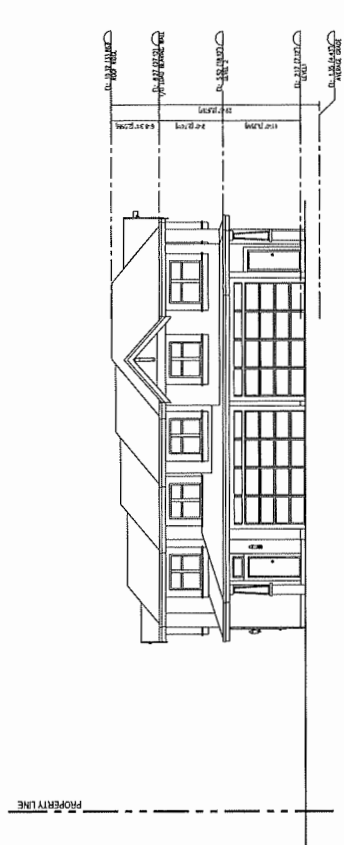

1. BUILDING C SOUTH ELEVATION  
 SCALE: 1/8"=1'-0"

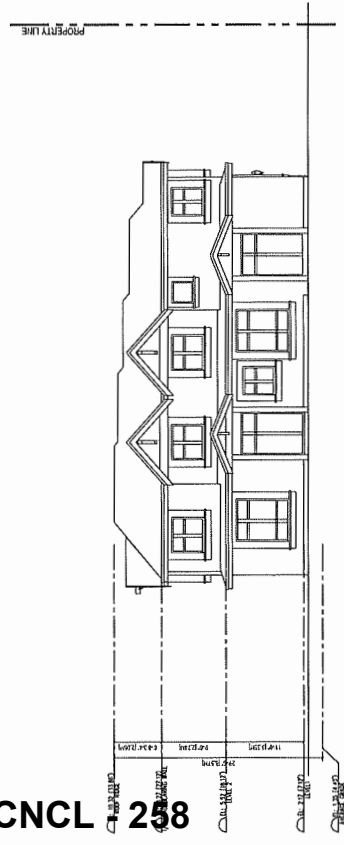

2. BUILDING C NORTH ELEVATION  
 SCALE: 1/8"=1'-0"

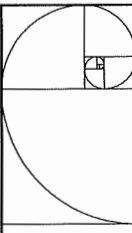

**IMPERIAL ARCHITECTURE**  
 A DIVISION OF AN ARCHITECTS OF PRACTICE  
 4000 W. UNIVERSITY AVENUE, SUITE 100  
 RICHMOND, VIRGINIA 23220  
 (804) 281-1111  
 WWW.IMPERIALARCHITECTURE.COM

ARCHITECTURE  
 INTERIOR DESIGN  
 PLANNING

Copyright Reserved  
 No part of this drawing may be reproduced or transmitted in any form or by any means, electronic or mechanical, including photocopying, recording, or by any information storage and retrieval system, without the prior written permission of the architect.

Dimensions

Overall Length	36'-0"
Overall Width	24'-0"
Overall Height	12'-0"
Overall Area	864 sq. ft.
Overall Volume	10,368 cu. ft.

ISSUED FOR REZONING  
 RESUBMISSION  
 (2019-08-16)

Client: STEVENSON HWY TOWNHOUSE  
 DEVELOPMENT FOR  
**AKONIC**  
 PARTNERS  
 4571 STEVENSON HWY.  
 RICHMOND, VA 23234 (804) 281-1111

PROJECT: BUILDING D & E ELEVATIONS

Sheet: A 3.5  
 Scale: 1/8"=1'-0"  
 Date: 08/16/19

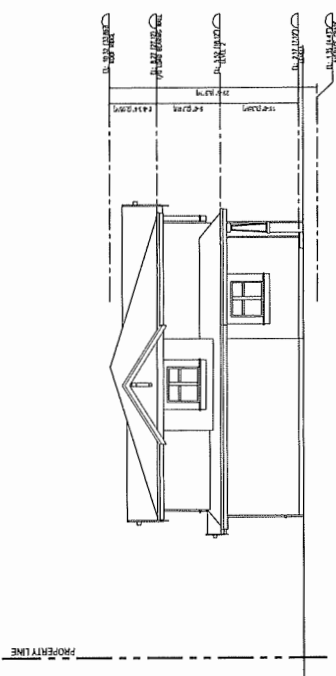

3 BUILDING D & E EAST ELEVATION  
 SCALE 1/8"=1'-0"

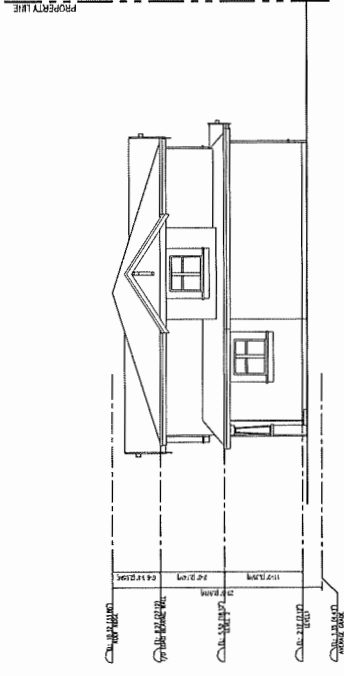

4 BUILDING D & E WEST ELEVATION  
 SCALE 1/8"=1'-0"

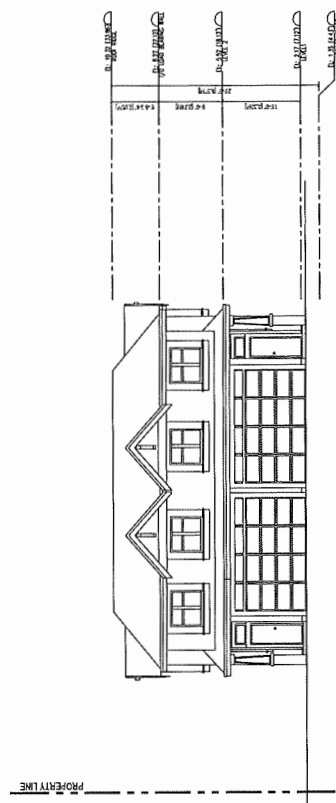

1 BUILDING D & E SOUTH ELEVATION  
 SCALE 1/8"=1'-0"

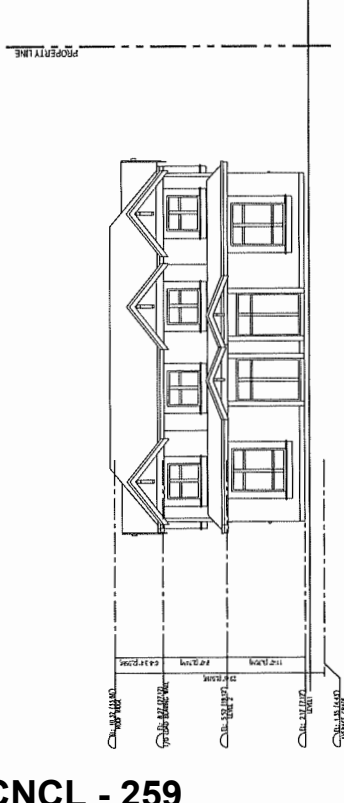

2 BUILDING D & E NORTH ELEVATION  
 SCALE 1/8"=1'-0"

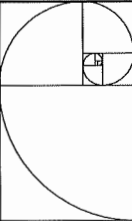

**IMPERIAL ARCHITECTURE**  
 LICENSED ARCHITECTS  
 401 E. 4th Street, Suite 100  
 Richmond, VA 23219  
 Phone: (804) 781-1111  
 Fax: (804) 781-1112  
 Website: www.imperialarch.com

Architect: [Name]  
 Designer: [Name]  
 Date: [Date]

Copyright Reserved  
 No part of this drawing may be reproduced or transmitted in any form or by any means electronic or mechanical, including photocopying, recording, or by any information storage and retrieval system, without the prior written permission of Imperial Architecture, Ltd.

**REVISIONS**

No.	Description	Date
1	ISSUED FOR REZONING RESUBMISSION (2019-08-16)	08/16/19
2		
3		
4		
5		
6		
7		
8		
9		
10		

ISSUED FOR REZONING  
 RESUBMISSION  
 (2019-08-16)

CLIENT: STEVENSON HWY. TOWNHOUSE  
 DEVELOPMENT FOR

**KONIG**  
 401 E. 4th St. Suite 100  
 RICHMOND, VA 23219

PROJECT: BUILDING SECTIONS

Scale: 1/8"=1'-0"  
 Drawing #: #8217  
 Sheet: A4.1

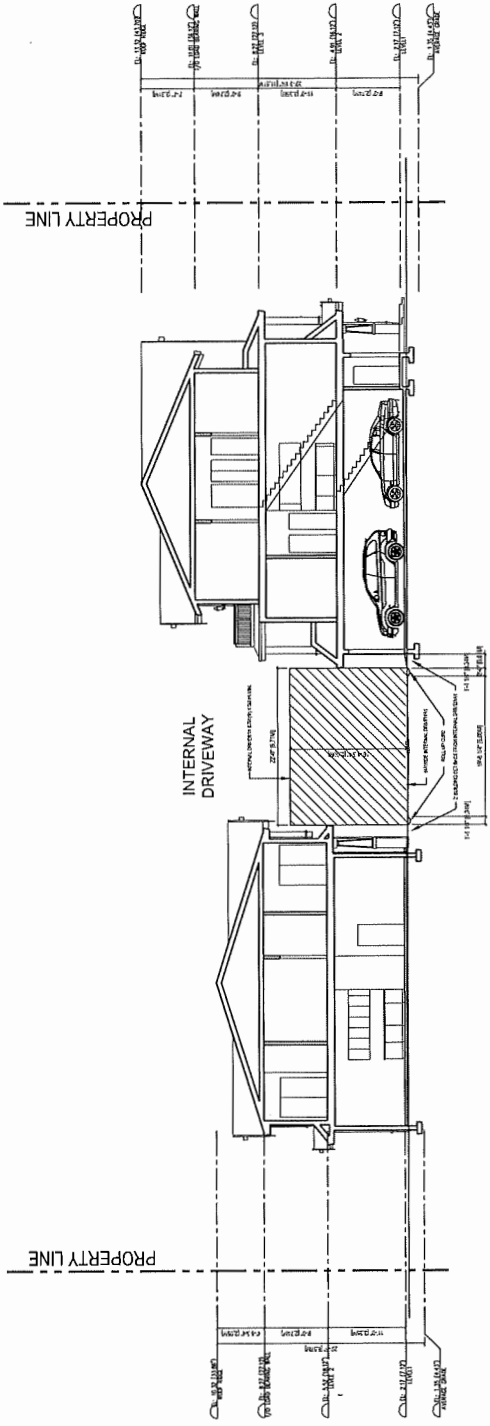

1 BUILDING D SECTION #1  
 SCALE: 1/8"=1'-0"  
 A4.1

2 BUILDING B SECTION #1  
 SCALE: 1/8"=1'-0"  
 A4.1

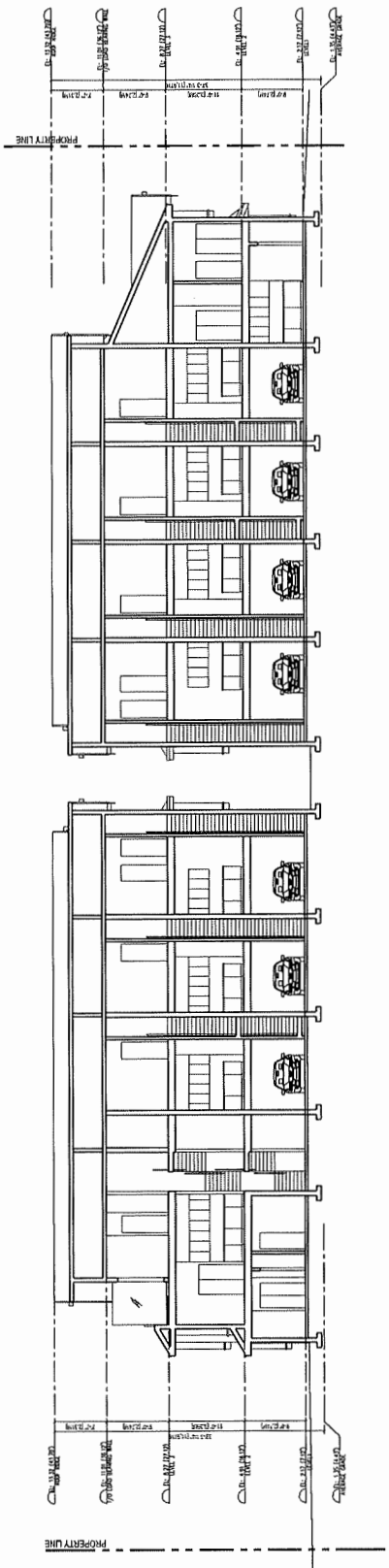

3 BUILDING AE SECTION #3  
 SCALE: 1/8"=1'-0"  
 A4.1

4 BUILDING B SECTION #2  
 SCALE: 1/8"=1'-0"  
 A4.1

© Copyright reserved. This drawing and design is the property of PMG Landscape Architects and may not be reproduced or used for other projects without their permission.

**pmg**  
**LANDSCAPE ARCHITECTS**  
 1000 Lakeside Drive  
 Bristow, Virginia 22109  
 P: 800-254-0011 T: 800-254-0022

SCALE

NO.	DATE	REVISION DESCRIPTION	BY
1		INITIAL DRAFT	
2		REVISION	
3		REVISION	
4		REVISION	
5		REVISION	
6		REVISION	
7		REVISION	
8		REVISION	
9		REVISION	
10		REVISION	

CLIENT:

PROJECT:

**16 UNIT TOWNHOUSE DEVELOPMENT**  
 4631 STEVENSON HIGHWAY  
 RICHMOND

DRAWING TITLE  
**LANDSCAPE PLAN**

DATE: 3/24/10 DRAWING NUMBER:  
 SCALE: 1/2"=1'-0" **L1**  
 DRAWN: JY  
 DESIGN: RJ  
 CHECKED: MCT  
 OF 2  
 PMG PROJECT NUMBER: 19-091



PLANT SCHEDULE	COMMON NAME	PLANTED SIZE / REMARKS
1	ACER BURBANCK RED SUNSET	110N GAL 70 STD. BAR
2	ACER BURBANCK RED SUNSET	50N GAL BAR
3	ACER BURBANCK RED SUNSET	110N GAL 70 STD. BAR
4	ACER BURBANCK RED SUNSET	110N GAL 70 STD. BAR
5	ACER BURBANCK RED SUNSET	110N GAL 70 STD. BAR
6	ACER BURBANCK RED SUNSET	110N GAL 70 STD. BAR
7	ACER BURBANCK RED SUNSET	110N GAL 70 STD. BAR
8	ACER BURBANCK RED SUNSET	110N GAL 70 STD. BAR
9	ACER BURBANCK RED SUNSET	110N GAL 70 STD. BAR
10	ACER BURBANCK RED SUNSET	110N GAL 70 STD. BAR
11	ACER BURBANCK RED SUNSET	110N GAL 70 STD. BAR
12	ACER BURBANCK RED SUNSET	110N GAL 70 STD. BAR
13	ACER BURBANCK RED SUNSET	110N GAL 70 STD. BAR
14	ACER BURBANCK RED SUNSET	110N GAL 70 STD. BAR
15	ACER BURBANCK RED SUNSET	110N GAL 70 STD. BAR
16	ACER BURBANCK RED SUNSET	110N GAL 70 STD. BAR
17	ACER BURBANCK RED SUNSET	110N GAL 70 STD. BAR
18	ACER BURBANCK RED SUNSET	110N GAL 70 STD. BAR
19	ACER BURBANCK RED SUNSET	110N GAL 70 STD. BAR
20	ACER BURBANCK RED SUNSET	110N GAL 70 STD. BAR
21	ACER BURBANCK RED SUNSET	110N GAL 70 STD. BAR
22	ACER BURBANCK RED SUNSET	110N GAL 70 STD. BAR
23	ACER BURBANCK RED SUNSET	110N GAL 70 STD. BAR
24	ACER BURBANCK RED SUNSET	110N GAL 70 STD. BAR
25	ACER BURBANCK RED SUNSET	110N GAL 70 STD. BAR
26	ACER BURBANCK RED SUNSET	110N GAL 70 STD. BAR
27	ACER BURBANCK RED SUNSET	110N GAL 70 STD. BAR
28	ACER BURBANCK RED SUNSET	110N GAL 70 STD. BAR
29	ACER BURBANCK RED SUNSET	110N GAL 70 STD. BAR
30	ACER BURBANCK RED SUNSET	110N GAL 70 STD. BAR
31	ACER BURBANCK RED SUNSET	110N GAL 70 STD. BAR
32	ACER BURBANCK RED SUNSET	110N GAL 70 STD. BAR
33	ACER BURBANCK RED SUNSET	110N GAL 70 STD. BAR
34	ACER BURBANCK RED SUNSET	110N GAL 70 STD. BAR
35	ACER BURBANCK RED SUNSET	110N GAL 70 STD. BAR
36	ACER BURBANCK RED SUNSET	110N GAL 70 STD. BAR
37	ACER BURBANCK RED SUNSET	110N GAL 70 STD. BAR
38	ACER BURBANCK RED SUNSET	110N GAL 70 STD. BAR
39	ACER BURBANCK RED SUNSET	110N GAL 70 STD. BAR
40	ACER BURBANCK RED SUNSET	110N GAL 70 STD. BAR
41	ACER BURBANCK RED SUNSET	110N GAL 70 STD. BAR
42	ACER BURBANCK RED SUNSET	110N GAL 70 STD. BAR
43	ACER BURBANCK RED SUNSET	110N GAL 70 STD. BAR
44	ACER BURBANCK RED SUNSET	110N GAL 70 STD. BAR
45	ACER BURBANCK RED SUNSET	110N GAL 70 STD. BAR
46	ACER BURBANCK RED SUNSET	110N GAL 70 STD. BAR
47	ACER BURBANCK RED SUNSET	110N GAL 70 STD. BAR
48	ACER BURBANCK RED SUNSET	110N GAL 70 STD. BAR
49	ACER BURBANCK RED SUNSET	110N GAL 70 STD. BAR
50	ACER BURBANCK RED SUNSET	110N GAL 70 STD. BAR
51	ACER BURBANCK RED SUNSET	110N GAL 70 STD. BAR
52	ACER BURBANCK RED SUNSET	110N GAL 70 STD. BAR
53	ACER BURBANCK RED SUNSET	110N GAL 70 STD. BAR
54	ACER BURBANCK RED SUNSET	110N GAL 70 STD. BAR
55	ACER BURBANCK RED SUNSET	110N GAL 70 STD. BAR
56	ACER BURBANCK RED SUNSET	110N GAL 70 STD. BAR
57	ACER BURBANCK RED SUNSET	110N GAL 70 STD. BAR
58	ACER BURBANCK RED SUNSET	110N GAL 70 STD. BAR
59	ACER BURBANCK RED SUNSET	110N GAL 70 STD. BAR
60	ACER BURBANCK RED SUNSET	110N GAL 70 STD. BAR
61	ACER BURBANCK RED SUNSET	110N GAL 70 STD. BAR
62	ACER BURBANCK RED SUNSET	110N GAL 70 STD. BAR
63	ACER BURBANCK RED SUNSET	110N GAL 70 STD. BAR
64	ACER BURBANCK RED SUNSET	110N GAL 70 STD. BAR
65	ACER BURBANCK RED SUNSET	110N GAL 70 STD. BAR
66	ACER BURBANCK RED SUNSET	110N GAL 70 STD. BAR
67	ACER BURBANCK RED SUNSET	110N GAL 70 STD. BAR
68	ACER BURBANCK RED SUNSET	110N GAL 70 STD. BAR
69	ACER BURBANCK RED SUNSET	110N GAL 70 STD. BAR
70	ACER BURBANCK RED SUNSET	110N GAL 70 STD. BAR
71	ACER BURBANCK RED SUNSET	110N GAL 70 STD. BAR
72	ACER BURBANCK RED SUNSET	110N GAL 70 STD. BAR
73	ACER BURBANCK RED SUNSET	110N GAL 70 STD. BAR
74	ACER BURBANCK RED SUNSET	110N GAL 70 STD. BAR
75	ACER BURBANCK RED SUNSET	110N GAL 70 STD. BAR
76	ACER BURBANCK RED SUNSET	110N GAL 70 STD. BAR
77	ACER BURBANCK RED SUNSET	110N GAL 70 STD. BAR
78	ACER BURBANCK RED SUNSET	110N GAL 70 STD. BAR
79	ACER BURBANCK RED SUNSET	110N GAL 70 STD. BAR
80	ACER BURBANCK RED SUNSET	110N GAL 70 STD. BAR
81	ACER BURBANCK RED SUNSET	110N GAL 70 STD. BAR
82	ACER BURBANCK RED SUNSET	110N GAL 70 STD. BAR
83	ACER BURBANCK RED SUNSET	110N GAL 70 STD. BAR
84	ACER BURBANCK RED SUNSET	110N GAL 70 STD. BAR
85	ACER BURBANCK RED SUNSET	110N GAL 70 STD. BAR
86	ACER BURBANCK RED SUNSET	110N GAL 70 STD. BAR
87	ACER BURBANCK RED SUNSET	110N GAL 70 STD. BAR
88	ACER BURBANCK RED SUNSET	110N GAL 70 STD. BAR
89	ACER BURBANCK RED SUNSET	110N GAL 70 STD. BAR
90	ACER BURBANCK RED SUNSET	110N GAL 70 STD. BAR
91	ACER BURBANCK RED SUNSET	110N GAL 70 STD. BAR
92	ACER BURBANCK RED SUNSET	110N GAL 70 STD. BAR
93	ACER BURBANCK RED SUNSET	110N GAL 70 STD. BAR
94	ACER BURBANCK RED SUNSET	110N GAL 70 STD. BAR
95	ACER BURBANCK RED SUNSET	110N GAL 70 STD. BAR
96	ACER BURBANCK RED SUNSET	110N GAL 70 STD. BAR
97	ACER BURBANCK RED SUNSET	110N GAL 70 STD. BAR
98	ACER BURBANCK RED SUNSET	110N GAL 70 STD. BAR
99	ACER BURBANCK RED SUNSET	110N GAL 70 STD. BAR
100	ACER BURBANCK RED SUNSET	110N GAL 70 STD. BAR

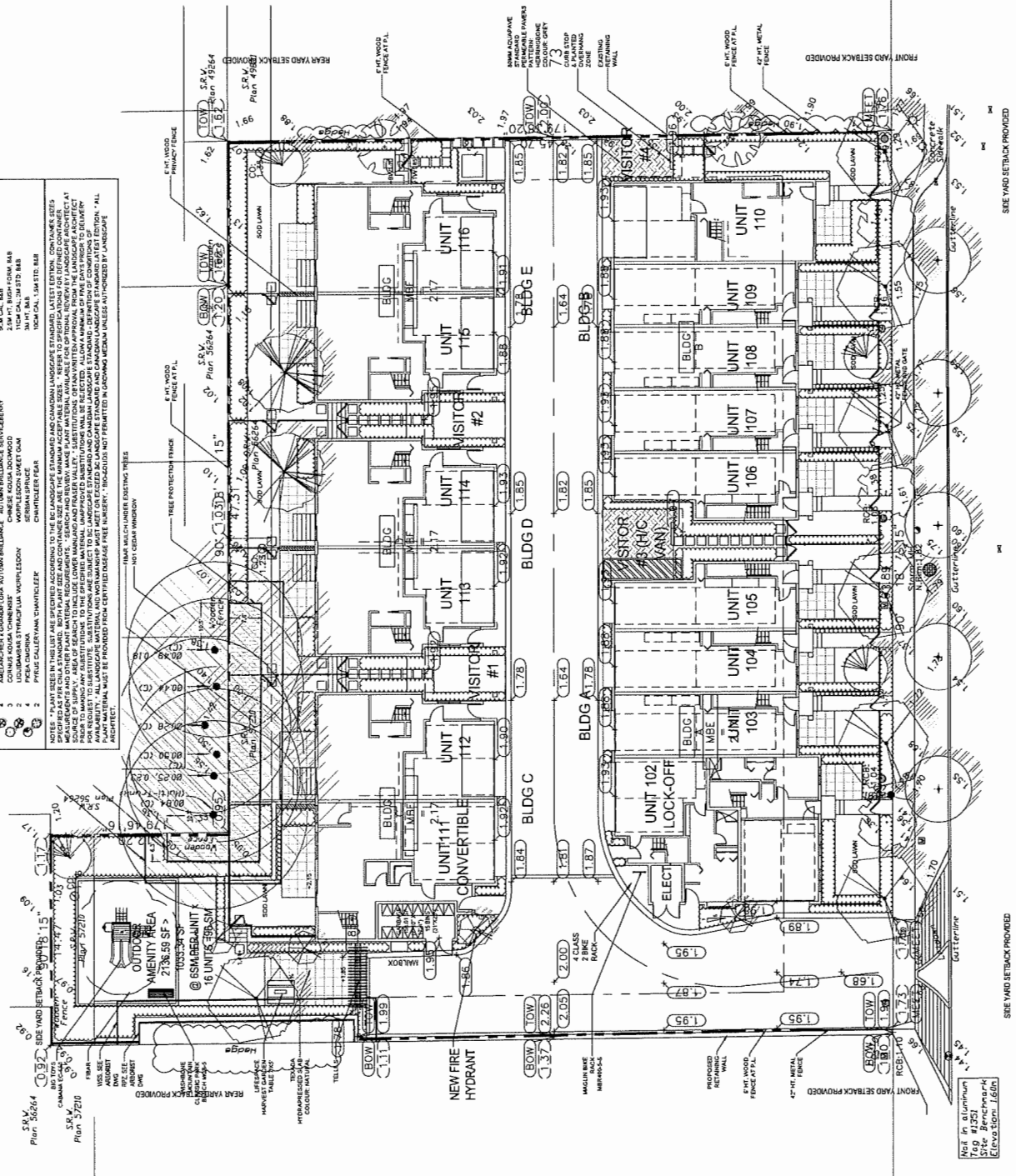

SEAL:

NO.	DATE	REVISION DESCRIPTION	BY
1	23.04.23	ISSUE FOR PERMIT	DL
2	23.04.23	ISSUE FOR PERMIT	DL
3	23.04.23	ISSUE FOR PERMIT	DL
4	23.04.23	ISSUE FOR PERMIT	DL
5	23.04.23	ISSUE FOR PERMIT	DL
6	23.04.23	ISSUE FOR PERMIT	DL
7	23.04.23	ISSUE FOR PERMIT	DL
8	23.04.23	ISSUE FOR PERMIT	DL
9	23.04.23	ISSUE FOR PERMIT	DL
10	23.04.23	ISSUE FOR PERMIT	DL
11	23.04.23	ISSUE FOR PERMIT	DL
12	23.04.23	ISSUE FOR PERMIT	DL
13	23.04.23	ISSUE FOR PERMIT	DL
14	23.04.23	ISSUE FOR PERMIT	DL
15	23.04.23	ISSUE FOR PERMIT	DL
16	23.04.23	ISSUE FOR PERMIT	DL
17	23.04.23	ISSUE FOR PERMIT	DL
18	23.04.23	ISSUE FOR PERMIT	DL
19	23.04.23	ISSUE FOR PERMIT	DL
20	23.04.23	ISSUE FOR PERMIT	DL

CLIENT:

PROJECT:  
**16 UNIT TOWNHOUSE DEVELOPMENT**  
4633 STEVENSON HIGHWAY  
RICHMOND

DRAWING TITLE:  
**LANDSCAPE DETAILS**

DATE: 23-JUN-23 DRAWING NUMBER: **L2**  
SCALE: AS SHOWN DRAWN: N/ DESIGN: N/ CHECKED: N/ NO. OF SHEETS: 2 OF 2  
PMG PROJECT NUMBER: 19-091

- NOTES:**
1. ALL WOOD POSTS TO BE PRESURE TREATED TO CSA STANDARDS AND END CUTS TREATED WITH PRESERVATIVE.
  2. ALL HARDWARE TO BE HOT-DIPPED GALVANIZED.
  3. ALL HARDWARE TO BE CLEAR, 4:1 CONSTRUCTION GRADE SPUNNAC.
  4. ALL HARDWARE NOT DOUBLE DIPPED GALVANIZED.
  5. APPLY 7 COATS APPLY 2 COATS OF BURNHAM MOORE GARMENT VAIL.

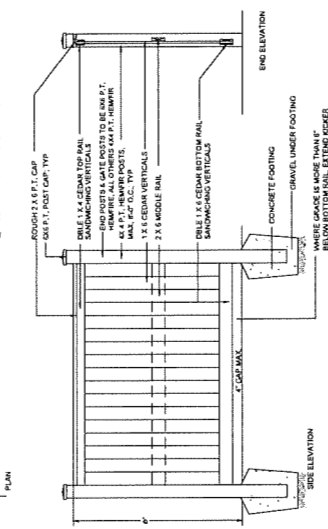

**1 6' HT. WOOD PRIVACY FENCE**  
1/2" x 1/2"

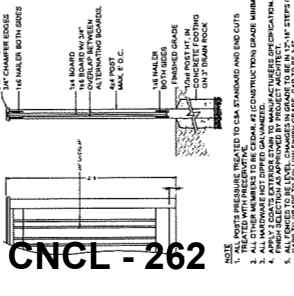

**3 6' HEIGHT SOLID WOOD FENCE**  
1/2" x 1/2"

- NOTES:**
1. ALL WOOD POSTS TO BE PRESURE TREATED TO CSA STANDARDS AND END CUTS TREATED WITH PRESERVATIVE.
  2. ALL HARDWARE TO BE HOT-DIPPED GALVANIZED.
  3. ALL HARDWARE TO BE CLEAR, 4:1 CONSTRUCTION GRADE SPUNNAC.
  4. ALL HARDWARE NOT DOUBLE DIPPED GALVANIZED.
  5. APPLY 7 COATS APPLY 2 COATS OF BURNHAM MOORE GARMENT VAIL.

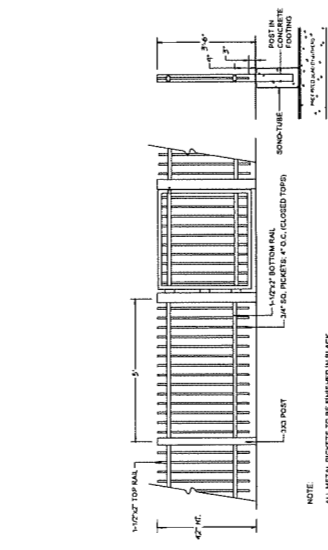

**2 42\"/>**

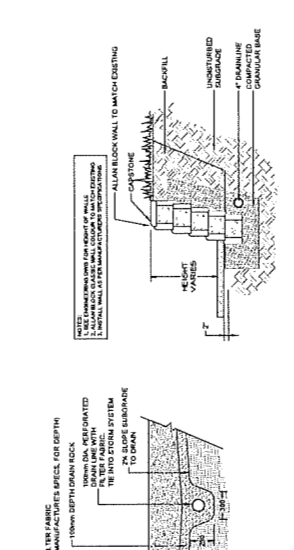

**5 ALLAN BLOCK WALL**  
1/2" x 1/2"

- NOTES:**
1. ALL WOOD POSTS TO BE PRESURE TREATED TO CSA STANDARDS AND END CUTS TREATED WITH PRESERVATIVE.
  2. ALL HARDWARE TO BE HOT-DIPPED GALVANIZED.
  3. ALL HARDWARE TO BE CLEAR, 4:1 CONSTRUCTION GRADE SPUNNAC.
  4. ALL HARDWARE NOT DOUBLE DIPPED GALVANIZED.
  5. APPLY 7 COATS APPLY 2 COATS OF BURNHAM MOORE GARMENT VAIL.

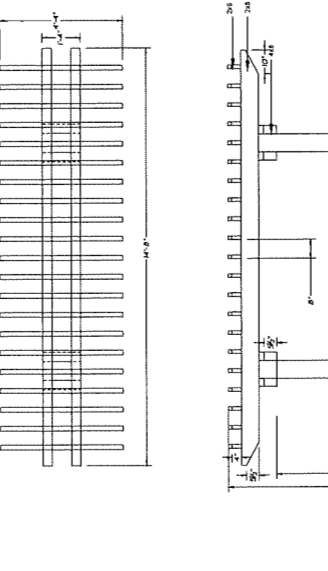

**6 TRELLIS**  
1/2" x 1/2"

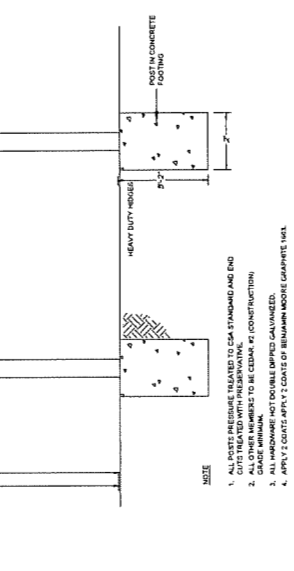

**4 PLAYGROUND SAFETY SURFACE**  
1/2" x 1/2"

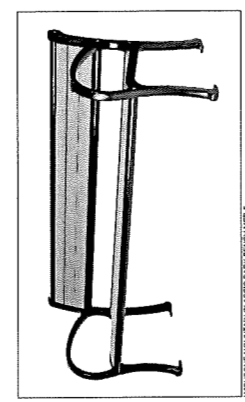
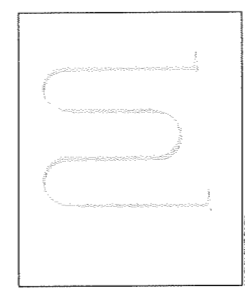

**CNCL - 262**

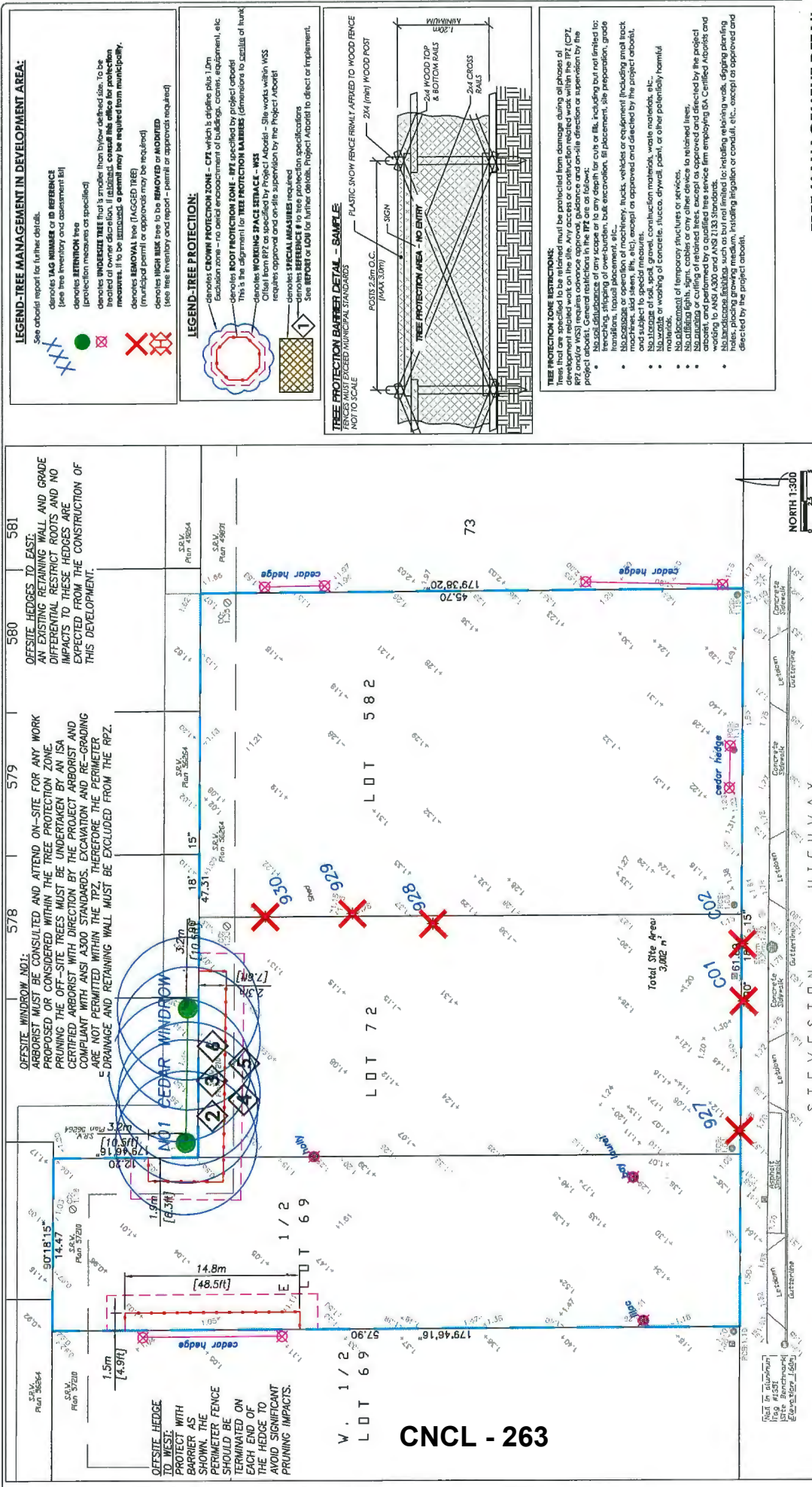

**LEGEND - TREE MANAGEMENT IN DEVELOPMENT AREA:**

- See arborist report for further details.
- denotes TAG NUMBER or ID REFERENCE (see tree inventory and assessment list)
- denotes ATTENTION tree (protection measure as specified)
- denotes PROPOSED TREE that is smaller than below defined size to be located at owner's discretion, if (allowed), consult this office for protection measures. If to be removed, a permit may be required from municipality.
- denotes REMOVAL tree (TAGGED TREE) (multiple permit or approvals may be required)
- denotes WHICH SIDE tree to be REMOVED or MODIFIED (see tree inventory and report - permit or approvals required)

**LEGEND - TREE PROTECTION:**

- denotes KNOWN PROTECTION ZONE - CZT which is, dipole plus 1.0m Exclusion zone - no aerial encroachment of buildings, cranes, equipment, etc
- denotes ROOT PROTECTION ZONE - RPZ specified by project arborist This is the minimum for TREE PROTECTION BARRIERS (dimensions to outside of trunk)
- denotes WORKING SPACE STRIKE - WSS (Call) from RPZ as specified by Project Arborist - Site works within WSS requires approval and on-site supervision by the Project Arborist
- denotes SPECIAL MEASURES required
- denotes REFERENCE # to tree protection specifications
- See REPORT or LOG for further details, Project Arborist to effect or implement.

**TREE PROTECTION BARRIER DETAIL - SAMPLE**

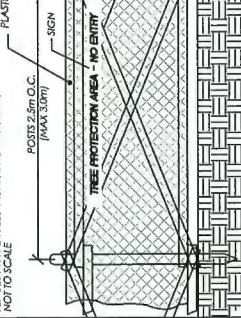

**TREE PROTECTION ZONE INSTRUCTIONS:**

- Areas that are adjacent to the RPZ must be protected from damage during all phases of development related work on the site. Any access or construction related work within the RPZ (CZT and/or WSS) requires advance approval, guidance and on-site direction or supervision by the project arborist. General restrictions in the RPZ are as follows:
  - No excavation or any other activity that may impact the tree's root system or soil structure, including, but not limited to, foundations, in-situ placement, etc.
  - No storage or operation of machinery, trucks, vehicles or equipment (including small track loaders) within the RPZ, except as approved and directed by the project arborist.
  - No use of salt, spot, gravel, construction material, waste materials, etc.
  - No use of concrete, masonry, concrete, blocks, bricks, or other potentially harmful materials.
  - No use of temporary structures or services.
  - No additional lights, signs, cables or any other device to retained trees.
  - No alteration or cutting of retained trees, except as approved and directed by the project arborist, and performed by a qualified tree service firm employing ISA Certified Arborists and trained staff.
  - No landscape fabric, such as but not limited to, installing retaining walls, spacing planting holes, placing growing medium, installing irrigation or conduit, etc., except as approved and directed by the project arborist.

OFFSITE HEDGES TO EAST: AN EXISTING RETAINING WALL AND GRADE DIFFERENTIAL RESTRICT ROOTS AND NO IMPACTS TO THESE HEDGES ARE EXPECTED FROM THE CONSTRUCTION OF THIS DEVELOPMENT.

OFFSITE WINDROW, NO.1: ARBORIST MUST BE CONSULTED AND ATTEND ON-SITE FOR ANY WORK PROPOSED OR CONSIDERED WITHIN THE TREE PROTECTION ZONE. PRUNING THE OFF-SITE TREES MUST BE UNDERTAKEN BY AN ISA CERTIFIED ARBORIST WITH DIRECTION BY THE PROJECT ARBORIST AND COMPLIANT WITH ANSI A300 STANDARDS, EXCAVATION AND RE-GRADING ARE NOT PERMITTED WITHIN THE TPZ, THEREFORE THE PERIMETER = DRAINAGE AND RETAINING WALL MUST BE EXCLUDED FROM THE RPZ.

OFFSITE HEDGE TO WEST: PROTECT WITH BARRIER AS SHOWN. THE PERIMETER FENCE SHOULD BE TERMINATED ON EACH END OF THE HEDGE TO AVOID SIGNIFICANT PRUNING IMPACTS.

CNCL - 263

**APPENDIX C: TREE MANAGEMENT DRAWING - SHEET 2**

tree management detail

PROJECT: PROPOSED TOWNHOUSE DEVELOPMENT

ADDRESS: 4571, 4571, 4611 STEVESTON HIGHWAY

CITY: STEVESTON

CLIENT: KONIC DEVELOPMENT

CITY REF: 18284

PLOT SIZE: 11'x17' REV #: 1 DATE: JUN 20, 2019

accigroup.co

SUITE 145 - 12051 HORSBOWE WAY, RICHMOND, BC V7A 4V4 604-275 5868



**Address:** 4571, 4591, and 4611/4631 Steveston Highway

**File No.:** RZ 18-839945

**Prior to final adoption of Richmond Zoning Bylaw 8500, Amendment Bylaw 10081, the developer is required to complete the following:**

1. The submission and processing of a Development Permit\* completed to a level deemed acceptable by the Director of Development.
2. Consolidation of all the lots into one development parcel (which will require the demolition of the existing dwellings).
3. Discharge of restrictive covenant RD85670, which reserves a portion of the property for future road construction.
4. Discharge of covenant BF506485, which restricts the property to a two-unit dwelling only.
5. City acceptance of the developer's offer to voluntarily contribute \$2,600 to the City's Tree Compensation Fund for the planting of replacement trees within the City.
6. Submission of a Contract entered into between the applicant and a Certified Arborist for supervision of any on-site works conducted within the tree protection zone of the trees to be retained. The Contract should include the scope of work to be undertaken, including: the proposed number of site monitoring inspections, and a provision for the Arborist to submit a post-construction assessment report to the City for review.
7. Registration of a flood indemnity covenant on title (Area A).
8. Registration of a statutory right-of-way (SRW), and/or other legal agreements or measures, as determined to the satisfaction of the Director of Development, over the entire area of the proposed driveway entry from Steveston Highway and the interior drive aisle, in favour of future residential development to the east and west. Language should be included in the SRW document that is City will not be responsible for maintenance or liability within the SRW area.
9. City acceptance of the developer's offer to voluntarily contribute \$0.85 per buildable square foot (e.g. \$16,480) to the City's public art fund.
10. Contribution of \$1,600 per dwelling unit (e.g. \$25,600) in-lieu of on-site indoor amenity space to go towards development of City facilities.
11. City acceptance of the developer's offer to voluntarily contribute \$8.50 per buildable square foot (e.g. \$164,798) to the City's affordable housing fund.
12. Registration of a legal agreement on Title prohibiting the conversion of the tandem parking area into habitable space.
13. Registration of a legal agreement on Title to ensure that the secondary suite cannot be stratified or otherwise held under separate title.
14. City acceptance of a \$5,700 cash contribution towards the upgrade of the existing special crosswalk at the Steveston Highway and Bonavista Gate intersection.

**Prior to a Development Permit\* being forwarded to the Development Permit Panel for consideration, the developer is required to:**

1. Submission of a Landscape Plan, prepared by a Registered Landscape Architect, to the satisfaction of the Director of Development. The Landscape Plan should:
  - comply with the guidelines of the OCP's Arterial Road Policy and should not include hedges along the front property line;
  - include a mix of coniferous and deciduous trees;
  - include the dimensions of tree protection fencing as illustrated on the Tree Retention Plan attached to this report; and
  - include the 8 required replacement trees with the following minimum sizes:



No. of Replacement Trees	Minimum Caliper of Deciduous Tree	Minimum Height of Coniferous Tree
6	11 cm	5.5 m
2	10 cm	6 m

If required replacement trees cannot be accommodated on-site, a cash-in-lieu contribution in the amount of \$500/tree to the City's Tree Compensation Fund for off-site planting is required.

2. Complete a proposed townhouse energy efficiency report and recommendations prepared by a Certified Energy Advisor which demonstrates how the proposed construction will meet or exceed Step 3 of the Energy Step Code for Part 9 construction (Climate Zone 4), in compliance with the Richmond Building Regulation Bylaw 7230.

**Prior to Development Permit\* being forwarded to Council for issuance, the developer is required to:**

1. Deposit of a Landscaping Security based on 100% of the cost estimate provided by the Landscape Architect, including installation costs and a 10% contingency.
2. Installation of appropriate tree protection fencing around all trees to be retained as part of the development prior to any construction activities, including building demolition, occurring on-site.

**Prior to Building Permit Issuance, the developer must complete the following requirements:**

1. Submission of a Construction Parking and Traffic Management Plan to the Transportation Department. Management Plan shall include location for parking for services, deliveries, workers, loading, application for any lane closures, and proper construction traffic controls as per Traffic Control Manual for works on Roadways (by Ministry of Transportation) and MMCD Traffic Regulation Section 01570.
2. Incorporation of accessibility measures in Building Permit (BP) plans as determined via the Rezoning and/or Development Permit processes.
3. Obtain a Building Permit (BP) for any construction hoarding. If construction hoarding is required to temporarily occupy a public street, the air space above a public street, or any part thereof, additional City approvals and associated fees may be required as part of the Building Permit. For additional information, contact the Building Approvals Department at 604-276-4285.
4. Enter into a Servicing Agreement\* for the design and construction of engineering infrastructure improvements. A Letter of Credit or cash security for the value of the Service Agreement works, as determined by the City, will be required as part of entering into the Servicing Agreement. Works include, but may not be limited to:

*Water Works:*

- a) Using the OCP Model, there is 714.0 L/s of water available at a 20 psi residual at the Steveston Highway frontage. Based on your proposed development, your site requires a minimum fire flow of 220 L/s.
- b) At Developer's cost, the Developer is required to:
  - (1) Submit Fire Underwriter Survey (FUS) or International Organization for Standardization (ISO) fire flow calculations to confirm development has adequate fire flow for onsite fire protection. Calculations must be signed and sealed by a Professional Engineer and be based on Building Permit Stage building designs.
  - (2) Review hydrant spacing on Steveston Highway frontage and install new fire hydrants as required to meet City spacing requirements for the proposed land use.
  - (3) Provide a right-of-way on site for the water meter. Exact right-of-way dimensions to be finalized via the servicing agreement process.
- c) At Developer's cost, the City will:
  - (1) Cut, cap, and remove existing water service connections along Steveston Highway frontage.
  - (2) Complete all tie-ins for the proposed works to existing City infrastructure.

*Storm Sewer Works:*

- a) At Developer's cost, the City will:
  - (1) Cut, cap, and remove existing storm connections at Steveston Highway frontage.

- (2) Install a new storm service connection to serve the proposed development.

*Sanitary Sewer Works:*

- a) At Developer's cost, the Developer is required to:
  - (1) Not start onsite excavation or foundation construction until completion of rear-yard sanitary works by City crews.
  - (2) Install a new sanitary service connection, location to be determined through the Servicing Agreement review process.
- b) At Developer's cost, the City will:
  - (1) Cut and cap at main all existing sanitary connections along property's rear-yard.
  - (2) Complete all tie-ins for the proposed works to existing City infrastructure.

*Frontage Improvements:*

- a) At Developer's cost, the Developer is required to:
  - (1) Coordinate with BC Hydro, Telus and other private communication service providers:
    - (a) To pre-duct for future hydro, telephone and cable utilities along all road frontages.
    - (b) Before relocating/modifying any of the existing power poles and/or guy wires within the property frontages.
    - (c) To underground overhead service lines.
  - (2) Locate/relocate all above ground utility cabinets and kiosks required to service the proposed development, and all above ground utility cabinets and kiosks located along the development's frontages, within the developments site (see list below for examples). A functional plan showing conceptual locations for such infrastructure shall be included in the development design review process. Please coordinate with the respective private utility companies and the project's lighting and traffic signal consultants to confirm the requirements (e.g., statutory right-of-way dimensions) and the locations for the aboveground structures. If a private utility company does not require an aboveground structure, that company shall confirm this via a letter to be submitted to the City. The following are examples of statutory right-of-ways that shall be shown on the architectural plans/functional plan, the servicing agreement drawings, and registered prior to SA design approval:
    - (a) BC Hydro PMT – 4.0 x 5.0 m
    - (b) BC Hydro LPT – 3.5 x 3.5 m
    - (c) Street light kiosk – 1.5 x 1.5 m
    - (d) Traffic signal kiosk – 2.0 x 1.5 m
    - (e) Traffic signal UPS – 1.0 x 1.0 m
    - (f) Shaw cable kiosk – 1.0 x 1.0 m
    - (g) Telus FDH cabinet – 1.1 x 1.0 m
  - (3) Review street lighting levels along all road and lane frontages, and upgrade as required.
  - (4) Complete the following frontage improvements as per Transportation's requirements:
    - (a) Remove existing sidewalk and replace with a new 1.5 m wide concrete sidewalk at the property line and a new minimum 1.5 m wide boulevard with street trees;
    - (b) Removal of existing driveways and replacement with concrete barrier curb/gutter and frontage works as described above; and
    - (c) Construct a new driveway crossing to the development site to provide right-in/right-out access only.

*General Items:*

a) At Developer's cost, the Developer is required to:

- (1) Provide, prior to start of site preparation works or within the first servicing agreement submission, whichever comes first, a preload plan and geotechnical assessment of preload, dewatering, and soil preparation impacts on the existing utilities fronting the development site and provide mitigation recommendations.
- (2) Provide a video inspection report of the adjacent existing storm and sanitary sewers prior to start of site preparation works or within the first servicing agreement submission, whichever comes first. A follow-up video inspection, complete with a civil engineer's signed and sealed recommendation letter, is required after site preparation works are complete (i.e. pre-load removal, completion of dewatering, etc.) to assess the condition of the existing utilities and provide recommendations to retain, replace, or repair. Any utilities damaged by the pre-load, de-watering, or other ground preparation shall be replaced or repaired at the Developer's cost.
- (3) Conduct pre- and post-preload elevation surveys of all surrounding roads, utilities, and structures. Any damage, nuisance, or other impact to be repaired at the developer's cost. The post-preload elevation survey shall be incorporated within the servicing agreement design.
- (4) Monitor the settlement at the adjacent utilities and structures during pre-loading, dewatering, and soil preparation works per a geotechnical engineer's recommendations, and report the settlement amounts to the City for approval.
- (5) Submit a proposed strategy at the building permit stage for managing excavation de-watering. Note that the City's preference is to manage construction water onsite or by removing and disposing at an appropriate facility. If this is not feasible due to volume of de-watering, the Developer will be required to apply to Metro Vancouver for a permit to discharge into the sanitary sewer system. If the sanitary sewer does not have adequate capacity to receive the volume of construction water, the Developer will be required to enter into a de-watering agreement with the City to discharge treated construction water to the storm sewer system.
- (6) Not encroach into City rights-of-ways with any proposed trees, retaining walls, or other non-removable structures.
- (7) Coordinate the servicing agreement design for this development with the servicing agreement(s) for the adjacent development(s), both existing and in-stream (if applicable). The developer's civil engineer shall submit a signed and sealed letter with each servicing agreement submission confirming that they have coordinated with civil engineer(s) of the adjacent project(s) and that the servicing agreement designs are consistent. The City will not accept the 1st submission if it is not coordinated with the adjacent developments. The coordination letter should cover, but not be limited to, the following:
  - (a) Corridors for City utilities (existing and proposed water, storm sewer, sanitary and DEU) and private utilities.
  - (b) Pipe sizes, material and slopes.
  - (c) Location of manholes and fire hydrants.
  - (d) Road grades, high points and low points.
  - (e) Alignment of ultimate and interim curbs.
  - (f) Proposed street lights design.
- (8) Enter into, if required, additional legal agreements, as determined via the subject development's Servicing Agreement(s) and/or Development Permit(s), and/or Building Permit(s) to the satisfaction of the Director of Engineering, including, but not limited to, site investigation, testing, monitoring, site preparation, de-watering, drilling, underpinning, anchoring, shoring, piling, pre-loading, ground densification or other activities that may result in settlement, displacement, subsidence, damage or nuisance to City and private utility infrastructure.

**Note:**

- \* This requires a separate application.
- Where the Director of Development deems appropriate, the preceding agreements are to be drawn not only as personal covenants of the property owner but also as covenants pursuant to Section 219 of the Land Title Act.

All agreements to be registered in the Land Title Office shall have priority over all such liens, charges and encumbrances as is considered advisable by the Director of Development. All agreements to be registered in the Land Title Office shall, unless the Director of Development determines otherwise, be fully registered in the Land Title Office prior to enactment of the appropriate bylaw.

The preceding agreements shall provide security to the City including indemnities, warranties, equitable/rent charges, letters of credit and withholding permits, as deemed necessary or advisable by the Director of Development. All agreements shall be in a form and content satisfactory to the Director of Development.

- Additional legal agreements, as determined via the subject development's Servicing Agreement(s) and/or Development Permit(s), and/or Building Permit(s) to the satisfaction of the Director of Engineering may be required including, but not limited to, site investigation, testing, monitoring, site preparation, de-watering, drilling, underpinning, anchoring, shoring, piling, pre-loading, ground densification or other activities that may result in settlement, displacement, subsidence, damage or nuisance to City and private utility infrastructure.
- Applicants for all City Permits are required to comply at all times with the conditions of the Provincial *Wildlife Act* and Federal *Migratory Birds Convention Act*, which contain prohibitions on the removal or disturbance of both birds and their nests. Issuance of Municipal permits does not give an individual authority to contravene these legislations. The City of Richmond recommends that where significant trees or vegetation exists on site, the services of a Qualified Environmental Professional (QEP) be secured to perform a survey and ensure that development activities are in compliance with all relevant legislation.

[signed concurrence on file]

---

Signed

---

Date



Richmond Zoning Bylaw 8500
Amendment Bylaw 10081 (RZ 18-839945)
4571, 4591, and 4611/4631 Steveston Highway

The Council of the City of Richmond, in open meeting assembled, enacts as follows:

- 1. The Zoning Map of the City of Richmond, which accompanies and forms part of Richmond Zoning Bylaw 8500, is amended by repealing the existing zoning designation of the following area and by designating it "LOW DENSITY TOWNHOUSES (RTL4)".

P.I.D. 002-088-665

The East Half of Lot 69 Section 35 Block 4 North Range 7 West New Westminster District Plan 30342

P.I.D. 003-790-355

Lot 72 Section 35 Block 4 North Range 7 West New Westminster District Plan 32545

P.I.D. 003-752-119

Lot 582 Section 35 Block 4 North Range 7 West New Westminster District Plan 56263

- 2. This Bylaw may be cited as "Richmond Zoning Bylaw 8500, Amendment Bylaw 10081".

FIRST READING

A PUBLIC HEARING WAS HELD ON

SECOND READING

THIRD READING

OTHER CONDITIONS SATISFIED

ADOPTED

Series of horizontal lines for recording readings and conditions.



MAYOR

CORPORATE OFFICER