



To: Planning Committee

To Planning - Oct 21, 2003

Date: October 8, 2003

From: Joe Erceg
Manager, Development Applications

RZ 03-223904

File: 8060-20-7605
8060-20-7606

**Re: APPLICATION BY BOB SNOWBALL AND WAYNE FOUGERE FOR REZONING
AT 12060, 12080, 12086, 12100 - 7TH AVENUE FROM LIGHT INDUSTRIAL
DISTRICT (I2) TO COMPREHENSIVE DEVELOPMENT DISTRICT (CD/78)**

Staff Recommendation

1. That Official Community Plan Amendment Bylaw No. 7605, which amends Official Community Plan Bylaw No. 7100 by repealing the existing generalized land use designation (Business and Industry) of 12060, 12080, 12086, 12100 7th Avenue in Attachment 1 (Generalized Land Use Map) to Schedule 1 (Richmond Official Community Plan) and designating it Neighbourhood Residential, be introduced and given first reading.

2. That Bylaw No. 7605, having been considered in conjunction with:

- the City's Financial Plan and Capital Program;
- the Greater Vancouver Regional District Solid Waste and Liquid Waste Management Plans;

is hereby deemed to be consistent with said program and plans, in accordance with Section 882(3)(a) of the Local Government Act.

3. That Bylaw No. 7605, having been examined in accordance with the City Policy No. 5039 on Consultation During OCP Development, is hereby deemed not to require further consultation.

4. Bylaw No. 7606, for the rezoning of 12060, 12080, 12086, 12100 - 7th Avenue from "Light Industrial District (I2)" to "Comprehensive Development District (CD/78)", be introduced and given first reading.

H. Balle

for

Joe Erceg
Manager, Development Applications

JE:dcb
Att. 7

FOR ORIGINATING DIVISION USE ONLY
CONCURRENCE OF GENERAL MANAGER
<i>[Signature]</i>

Staff Report

Origin

Bob Snowball and Wayne Fougere have applied for rezoning of 12060, 12080, 12086 and 12100 7th Avenue (refer to **Attachment 1**) from Light Industrial District (I2) to Comprehensive Development District (CD/78) in order to accommodate 10 detached single-family character townhouses. The property is located in quarter section 10-3-7 across from Garry Point Park. The proposal will also require an Official Community Plan (OCP) amendment to bring the OCP in line with the Steveston Area Plan and designate the subject properties for Neighbourhood Residential.

The townhouses proposed for this site are to be designed with a heritage appearance and with the capability of accommodating an internal elevator within half of the units (those units fronting 7th Avenue). The applicants have provided a development rationale statement which is provided in **Attachment 2**. As part of the development proposal, the owner is proposing to dedicate to the City, two heritage stilt houses currently situated on the property. A heritage interpretation package and several other off-site elements are also part of the proposal.

Preliminary site plans, offsite landscaping plans and heritage interpretation plans are provided in **Attachment 3**.

Findings of Fact

Item	Existing	Proposed
Owner	12060 7 th : Robert A. Snowball 12080 7 th : William & Eileen Carefoot 12086 7 th : William & Eileen Carefoot 12100 7 th : Robert A. & Alice L. Snowball William Carefoot, Eileen Carefoot	Same
Applicant	Robert A. Snowball and Wayne Fougere	Same
Site Size	12060 7 th : 919m ² (9892.36ft ²) 12080 7 th : 306m ² (3293.86ft ²) 12086 7 th : 306m ² (3293.86ft ²) 12100 7 th : 306m ² (3293.86ft ²) Combined area approximately 1837m ² (19773.95ft ²) (.454 acres)	same as combined area after consolidation.
Land Uses	Industrial	Multi-family Residential
OCP Designation	Business and Industry	Neighbourhood Residential
Area Plan Designation	Residential	Same
Zoning	Light Industrial District (I2)	Comprehensive Development District (CD/78)
Parking Required		2.0 stalls per unit + 0.2 stalls per unit for visitors for a total of 22 stalls

Item	Existing	Proposed
Parking Actual		2.0 stalls per unit + 0.2 stalls per unit for visitors for a total of 22 stalls
Heritage / Archaeological	A heritage notation exists on the southern 3 parcels: 12080 7 th / 12086 7 th / 12100 7 th – The notations refer to the two stilt houses and potential archaeological features on the site.	The proposal would see the two stilt houses dedicated to the City and relocated to the Britannia Heritage Ship Yard. Construction activity would monitor for any archaeological findings with a requirement to contact the appropriate Provincial authorities should anything be found.

Surrounding Development

- *North:* A 7 unit multi-family residential development (CD/19)
- *South and East:* Three primarily vacant industrial lots – currently used for open storage. These lots are controlled by the Steveston Harbour Authority.
- *West:* Garry Point Park

Related Policies & Studies

Heritage Conservation

Two dwellings situated on the properties are identified in the City’s Heritage Inventory as Stilt Piling House #1 and Stilt Piling House #2. The detailed Evaluation Worksheets for these two houses are provided in **Attachment 4**.

12080 and 12100 7th Avenue have heritage stilted houses located on them (which are proposed to be relocated to the Britannia Shipyard). 12086 and 12100 7th Avenue have also been identified as potential archaeological sites related to a previous Musqueam village located in the area. The rear laneway adjacent to this property also has a heritage significance having once served as "Ferry Road" – a connection to the former ferry landing in Steveston. The laneway once contained the ticket booth to the ferry.

The site is important:

- from an historical perspective because of the location of the historic stilt piling houses and the location of the CPR ferry loading ramp adjacent to the site, as identified in the Richmond Heritage Inventory; and
- from a potential archaeological perspective because the site may have formed part of a Musqueam village in the area.

The implications for development from the archaeological point of view is that there is potential that the archaeological remains may be unearthed when digging occurs on the site. Construction activity will be monitored by a registered archaeologist during any significant ground work.

The implications for development from the historical perspective relate to preservation of the structures and interpretation. While it is not possible to preserve stilt piling houses in-situ, the homes will be relocated for preservation on the Britannia Heritage Shipyard site. However, what

will be lost from this area is the sense that there once were homes located here (circa 1890) that had to be raised on stilts prior to adequate dyke protection being constructed.

The site will however, provide interpretation related to the former CPR ferry loading ramp. The ferry loading ramp is important as a reminder that the "Motor Princess" ferry regularly took passengers from Steveston to Sidney, as part of the larger Canadian Pacific transportation system, at a time when Richmond was growing into an economically viable municipality in the 1920's and beyond.

Development Permit Guidelines

The Steveston Area Plan's Detailed Development Permit Guidelines for Area D: 7th Avenue and Chatham Street apply to this site.

Industrial Buffer

Guidelines in the Richmond Official Community Plan (OCP) require industrial developments which abut residential areas to consider increasing setbacks to reduce impacts such as noise, odour, or shadow from any industrial building. The guidelines also specify the provision of a 6 m (19.7 ft) wide landscaped buffer where these conditions exist. The OCP does not similarly require residential developments to address these adjacency issues.

Consultation

The application has been reviewed by both the City's Heritage Commission (Feb 20, 2003 – minutes appear in **Attachment 5**) and the Design Panel (July 16, 2003 – excerpts from the minutes appear in **Attachment 6**).

The applicants have consulted with, and received approval to proceed from, staff with the Archaeological and Registry Services Branch of the Ministry of Sustainable Resource Management regarding potential archaeological resources on the site. A letter of approval appears in **Attachment 7**.

No other community / agency consultations were deemed necessary nor undertaken.

Project Proposal

During the course of discussions with staff, the applicant / owner has committed to the following:

- Dedication to the City of the two stilt houses currently located on the properties;
- A contribution of \$5000 toward the relocation of these structures – the current plan is to relocate these buildings to the Britannia Heritage Shipyard;
- A contribution of \$1000 per unit to the City in lieu of outdoor amenity space – it has been indicated that these funds would be earmarked for parks and trails use in the City;
- Design and construction of an asphalt walkway along the frontage of the subject property and extending north to Chatham Street. Staff are requesting through the proposed servicing agreement that the walkway be extended to Moncton Street;

- Design and construction of an asphalt walkway along a portion of the rear lane adjacent to the subject property and extending south to Moncton Street;
- Contributions for the design, fabrication and construction of a sign replicating the CPR Ferry Landing sign which formerly stood near the site as well as two heritage interpretation signs, an integrated wood deck and seating area in the vicinity of the former Ferry ticket booth location (preliminary value estimate is \$4,800 exclusive of taxes);
- The former Steveston – Sidney Ferry ramp rails will be examined for their condition and potential for interpretive usage during construction of the project. Barring a mutual City-developer agreement to indicate otherwise, upon use, soil and ground cover vegetation will be used to bury the railings to protect the remnants for the City's future considerations;
- Design, and installation of off-site landscaping and furnishings (e.g. bollards, lighting as required, etc.) to City standards as appropriate within a portion of the laneway adjacent to the property and within the ROW trail connection to Moncton Street;
- A quality designed and constructed heritage character development with provisions for half of the units to accommodate the installation of an elevator capable of addressing senior's / disabled individual's needs for assisted movement between floors.

Staff Comments

Parks Review

Ferry Lane is to act as both car access and a pedestrian trail from Chatham to Moncton as per the Trails Strategy. Some ground plane treatment is needed on the asphalt lane for pedestrian movement. The path along 7th Avenue should be extended to connect with the existing trail on Moncton.

Building Permits Review

- The use of all areas of the ground floor are to be clearly identified.
- The height of crawl spaces is to be reviewed through the development permit with a view to ensuring that it does not become habitable space.
- Floodplain requirements apply.
- An overall site plan showing fire fighting access, hydrant location, buildings, building access points etc. needs to be provided.
- Building Code issues such as: separation of buildings...openings including deck/porch areas needs to be provided. A code analysis should be provided for the development permit review.
- More detail should be provided on the drawings at the DP stage

Sanitation and Recycling

Garbage and recycling in the rear lane is acceptable with provision of an enclosure. A turn around area in the lane should also be provided for the garbage and recycling truck.

Transportation Review

- The walkway on 7th Avenue should be as close to the property line as possible. If there is no curb and gutter on 7th Avenue, street parking on 7th Avenue is still acceptable. Note, there is potential angle parking on east side of 7th Avenue in future.
- Further to the meeting of March 24, prefer garbage pickup to be done in lane (not off 7th Avenue).
- No parking will be permitted in the lane.
- All bylaws and regulations valid to a lane would continue to apply to the lane (e.g. no parking).
- Turnaround for servicing trucks (e.g. garbage and recycling) will be needed beyond driveway off of the lane. An "end of the road" checkerboard sign will be needed at south end of lane/road.
- Need more details on what the treatment on 7th Avenue is before commenting further; previously we had discussed curb and gutter edge with treed boulevard and sidewalk to Chatham, but drainage was an issue.

Heritage Review

From an archaeological perspective, the applicant has agreed to monitor the site during any land altering activities, for potential archeological remains.

In terms of the heritage aspects of the site, the applicant has agreed to relocate the heritage stilt piling houses. While all association to these former structures will be lost on site, they will still be visible at the Britannia Heritage Shipyard site.

The applicant has submitted a Heritage Interpretive Plan which focuses on the former use of the adjacent site for the CPR ferry. The main historical element, the steel girders or railings that formed part of the loading ramp, while still located in generally the right location, will not be used in the interpretation as it was determined that these ramps, if exposed, would likely corrode. The applicant has agreed to examine these railings with City staff during the construction phase to determine their condition and potential for interpretive usage. Baring a mutually agreed upon use to determine otherwise, the developer has agreed to use soil, grass and/or appropriate landscaping to bury the railings in-situ to protect the remnants for the City's future considerations. Care will need to be taken by the developer when constructing and landscaping the trail link to Moncton Street to avoid damage to the remaining rails.

The balance of the Interpretive Plan focuses on the re-creation of the Ferry Loading sign, construction of a portion of the ticket booth and two interpretive signs. Together, these materials will provide a reminder to residents and users of the adjacent trail of the former use on this adjacent site.

An agreement will be needed with the developer on the relocation of the two stilt houses to the Britannia site (i.e. date and timing of the relocation).

Policy Planning Review

At 0.784 FAR this development proposal comes in at the top end of the density scale for this type of development form in Steveston. It also provides only modest on-site outdoor open space

for the residents. The proposal does provide a number of important benefits for both the community and its future residents which merit consideration. Notably, the structures have provision for elevators, it is located across from Garry Point Park, its heritage design is compatible with Steveston character, contributions have been offered by the owner toward the relocation of the two heritage houses on site, research and interpretation of the ferry landing / artifacts/ ticket booth, the owner will provide a walkway from this site to Chatham St. along 7th Ave., and the grade change off Seventh Ave. allows for reduced visual impact of the building heights. Combined, these aspects compensate for many of the perceived negative concerns.

Overall, staff believe that the project is unique and has merit.

It is noted that the required flood plain elevation for this site is 2.6m geodetic. As such, crawl spaces should be constructed to ensure that they do not become habitable spaces.

The servicing agreement should include aspects related to the installation of the offsite landscaping plan and monies for the design, fabrication and installation of the heritage interpretive signage and features as noted earlier. Preliminary cost estimates for the landscaping and interpretive signage have been provided by the applicant. The servicing agreement is proposed to be a condition of final reading of the rezoning. The rezoning is proposed to be conditional of substantive completion of the development permit.

The implementation plan for the relocation of the stilt houses should be worked out with Heritage / Britannia staff prior to final reading of the rezoning.

Engineering and Services Review

Staff support the rezoning application. Prior to final reading, the developer must:

1. Consolidate all the lots into one development parcel.
2. Enter into the City's standard Servicing Agreement for design & construction of:
 - a) Improvements on Seventh Ave including alterations as required to the storm sewer system catch basins because of the developer's desire to fill their road frontage and construction of a 2m wide asphalt path running between Chatham Street and Moncton Street along 7th Avenue near the property line, and
 - b) Full width lane improvements from the north edge of the site, past the proposed driveway access including enough extra construction to provide a hammerhead type turnaround from the driveway, (i.e. there is no need to extend the lane across the full frontage). Works for the lane include storm sewer and street lighting as required. No curb and gutter is necessary as this extension is only 12m+/- and the existing lane is not guttered, and
 - c) Provide a walkway from the south edge of the new lane works, south to the Moncton Street ROW. Exact details and lighting standards are to be determined via the City's Development Applications staff working with Parks-Trails staff.
3. The need for an access control covenant will be determined via the Development Permit process.

Analysis

The applicant has worked with staff and the various Advisory Committees in order to address any potential concerns. The heritage appearance of the development should complement the historic foundations of the Steveston Community. While the site is quite dense relative to other Steveston developments, the attributes which this project brings to the neighbourhood work to mitigate these aspects.

Both the Heritage Commission and the Design Panel had few negative comments for this application. Suggestions made by the Heritage Commission to represent the remnants of the original Ferry terminal and to construct a replica of the original terminal signage appear to have been addressed within the project proposal. Design Panel members raised issue with the placement of the mailboxes at the rear entrance to the site which, it was suggested, would be vulnerable to break in and thefts. They also suggested the installation of appropriate lighting for the walkway on the east side of the site.

Aspects such as the placement of interpretive signage, mailbox kiosk location, etc., should be addressed at the development permit stage. Staff are proposing that final details related to landscaping of the ROW, heritage interpretation implementation and street furnishing details be resolved as a condition of final reading.

Options

Two options are proposed for consideration:

Option 1: Reject the application.

The primary reason for rejecting the application would be on the basis of density that is considered too high for this Steveston location.

Option 2: Approve the application (*Recommended*)

Selecting this option acknowledges the unique contributions that this proposal provides to the community both in terms of the character appearance of the buildings and in the opportunity it presents for preservation of the remaining stilt houses and the heritage interpretation of the ferry landing adjacent to the site.

Financial Impact

The relocation of the two stilt houses is expected to cost more than the \$5,000 dollars being offered. The City would be expected to pick up the balance of the moving costs. No detailed assessment of the condition of the two houses has been made.

The project will also result in a \$10,000 contribution to parks and trails in lieu of on-site outdoor amenity space. Funds will also be received from the proponent for design, fabrication and installation of two off-site interpretive signs and a replica Ferry Landing sign. The offsite landscaping and interpretation package is estimated to be worth approximately \$13,000 (taxes excluded).

Conclusion

Although the proposed development would result in a comparatively high density for this part of Steveston, overall staff believe that the project will provide a number of significant benefits to the community. On this basis staff believe that the application is unique, has merit and is supportable.



David Brownlee
Planner 2
(4200)

DCB:cas

There are requirements to be dealt with prior to final adoption:

1. Consolidation of the properties into one parcel.
2. Enter into the City's standard Servicing Agreement as indicated in the staff report. This Agreement should include and address, among other details, offsite landscaping installation requirements, asphalt walkway details and placement, and details related to the installation of furnishings such as bollards. The agreement should also include payment to the City for the design, fabrication and installation of the interpretive signage and the historic archway Ferry sign as per standard City practices.
3. Agree to an implementation plan (e.g. date and time, etc.) for the relocation of the stilt houses.
4. Transfer of ownership of the stilt houses
5. Processing of a Development Permit application to a level satisfactory to the Manager, Development Applications.

List of Attachments

Attachment 1	Location Map
Attachment 2	Development Rationale Statement
Attachment 3	Preliminary Site and Landscaping Plans
Attachment 4	Stilt House Evaluation Sheets
Attachment 5	Heritage Commission Minutes (Excerpt from February 20, 2003)
Attachment 6	Design Panel Minutes (Excerpt from July 16, 2003)
Attachment 7	Letter of Approval from the Ministry of Sustainable Resource Management

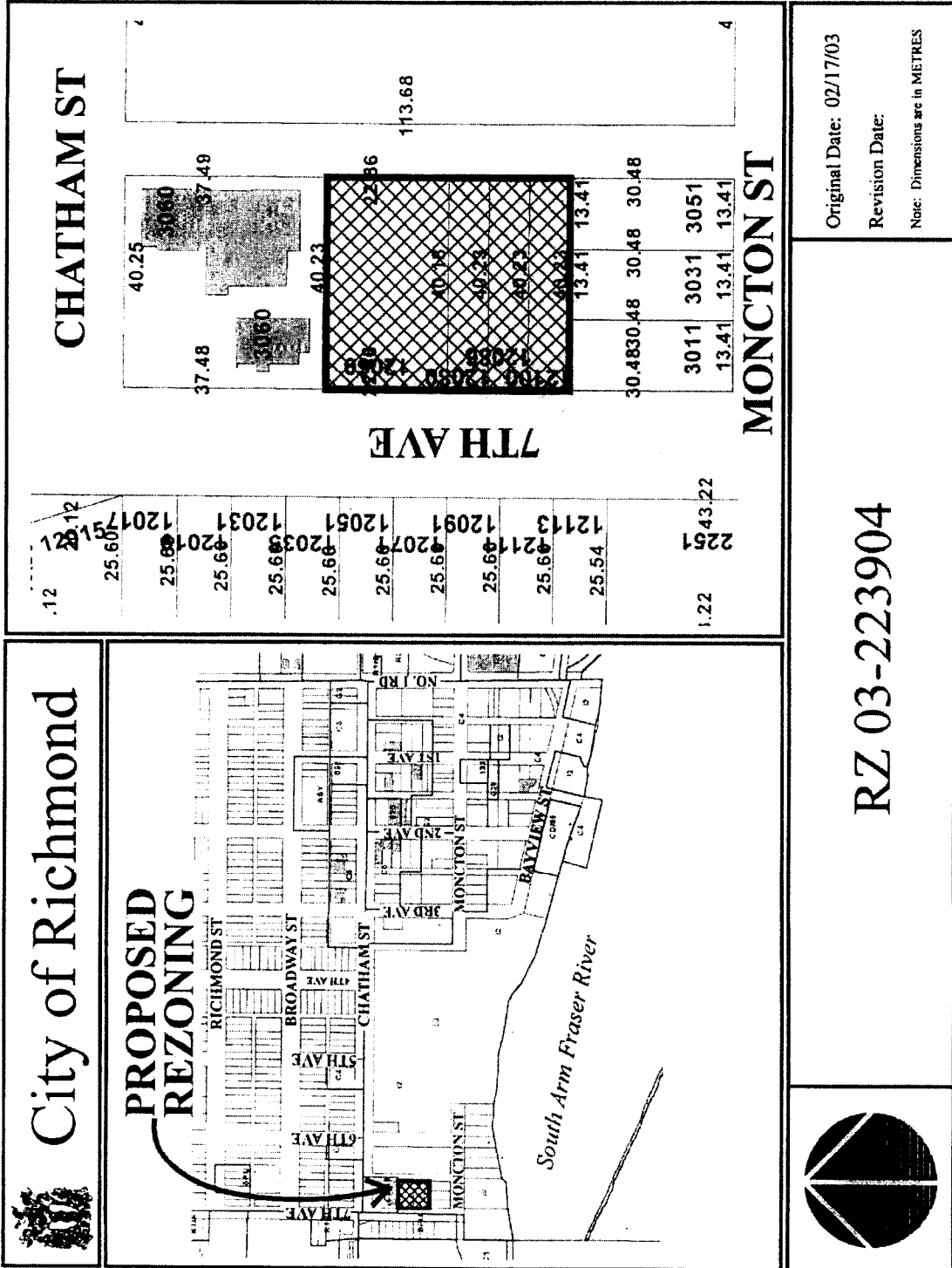

February 10, 2003

City of Richmond
6911 No. 3 Road
Richmond BC V6Y 2C1

Development Application Department:

Please accept this letter as authorization for Robert Snowball to act as "Authorized Agent" on our behalf in connection with the proposed development of property described below.

12060 7th Avenue Richmond BC
Parcel A Sec10 BLK3 NR7W NWD REF PL80025
LOT14A, 15A, 15B, BLK 14 SEC10 BLK3 NR7W NWD PL249

Robert Snowball (owner)



Alice Snowball (owner)

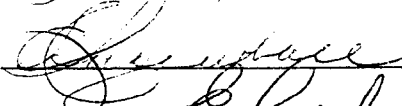

Eileen Carefoot (owner)

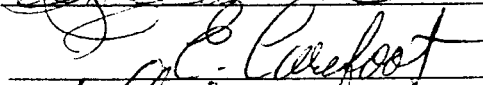

Foster Carefoot (owner)

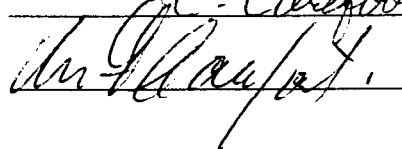



Looking West toward Garry Point Park

12060 SEVENTH AVENUE • DESIGN INTENT

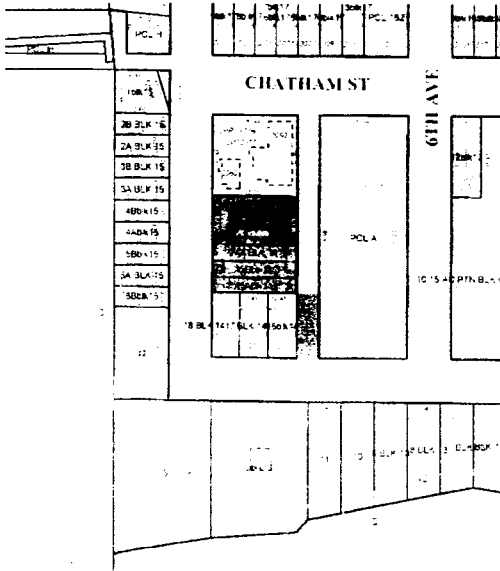

The site is 0.454 acres in size and while essentially level, is approximately half a storey below Seventh Avenue. There is an existing multi-family development immediately north of the site. Garry Point Park is located west of the site across Seventh Avenue. The partially open municipal roadway east of the site has been identified as the historic access to the Steveston-Sidney Ferry. A tribute to this landmark has been incorporated into the proposed Ferry Road improvements. Lands to the east of Ferry Road as well as the properties immediately south of the site are undeveloped.

The property is currently zoned industrial. Two existing residential structures designated as heritage pile housing occupy the south half of the site. These buildings have been offered to the City for incorporation into an historic setting at another location. Two industrial businesses utilize the remainder of the property.

More than 50% of the property's perimeter fronts municipal roadways.

This exposure to the community is the driving force of the design that presents residential streetscapes (composed of several individualized and duplexed ground-oriented homes) to both Seventh Avenue and Ferry Road. Each unit's entry faces a municipal street. Additionally, each home's major living areas (both interior and exterior) face outward to the Steveston community. A central auto court provides both vehicular access and an internal open space for the minor rooms of each home.

A three storey building form has been used to structurally elevate the living space above the 2.6m flood plain and to provide the opportunity for a raised front porch (characteristic of many single family homes in the Steveston area). The project is a heritage-inspired cluster of homes with a vocabulary that balances the rustic nature of a fishing village with the finer detailing common to vernacular Victorian style homes. A variety of native plant material has been used to reflect the rather unfinished landscape of a river front while at the same time classical plants such as Roses and Clematis have been used to compliment the Victorian architecture.

The project has been designed to appeal to retiring members of the Steveston community. In order to permit individuals to age-in-place and to provide more universally accessible dwellings, half of the homes have been designed to permit the installation of an elevator.



Original Ferry Terminal



Stilt Pile Housing

12060
7th AVENUE
STEVESTON
for Bob Snowball
JULY 2000
FOUGERE
ARCHITECTURE

8

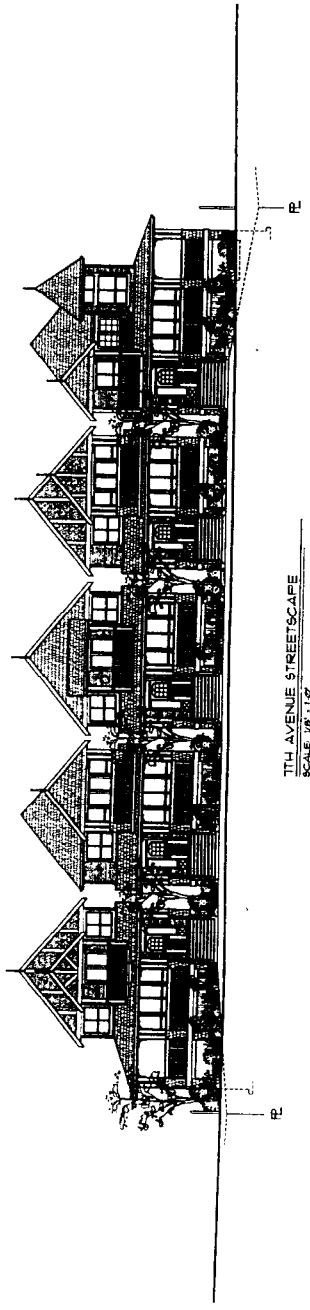

11TH AVENUE STREET SCENE
SCALE 1/8" = 1'-0"

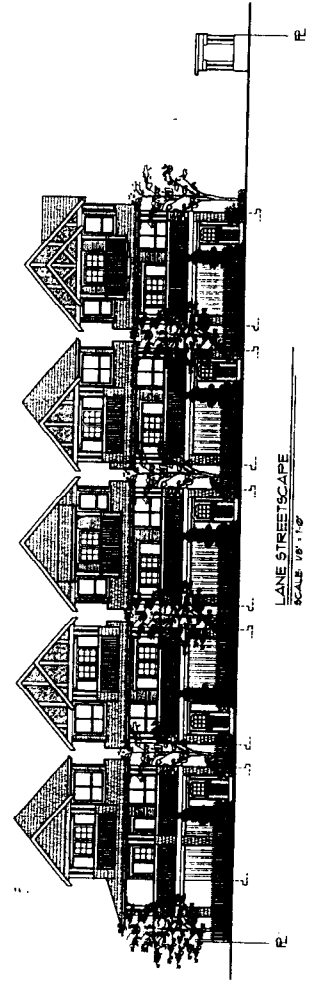

LANE STREET SCENE
SCALE 1/8" = 1'-0"

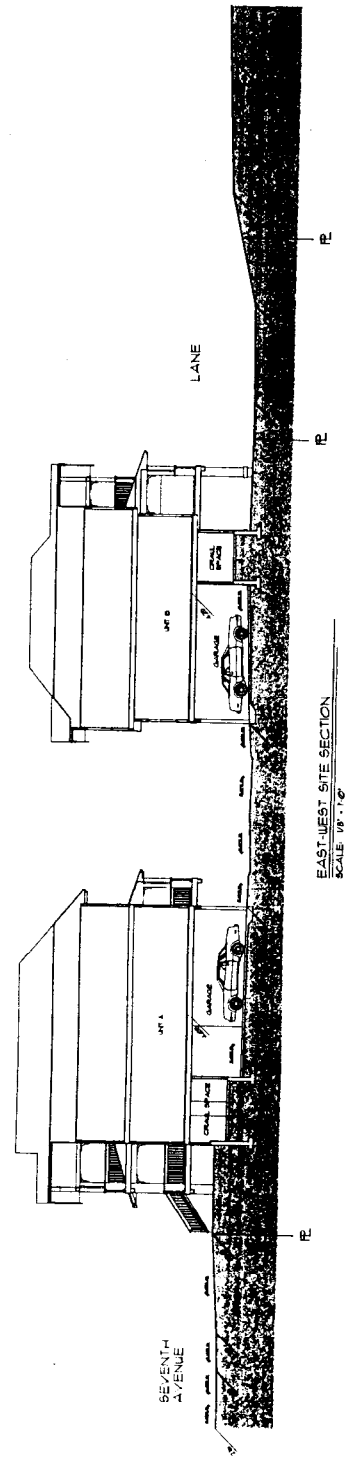

EAST-WEST SITE SECTION
SCALE 1/8" = 1'-0"

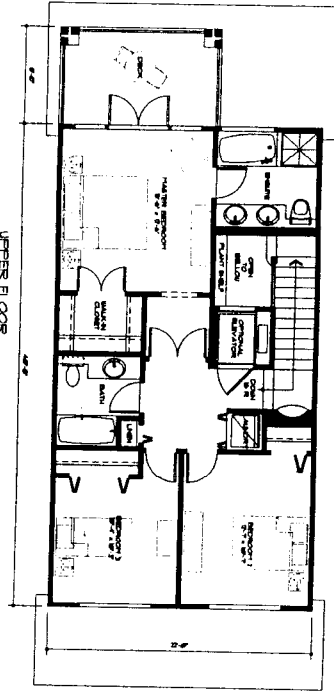

UNIT A
FLOOR AREA

Ground floor	68.0
Upper floor	71.6
TOTAL	139.6
Covered Deck	285.1
Accessories	28.0
Coverage	1294.0

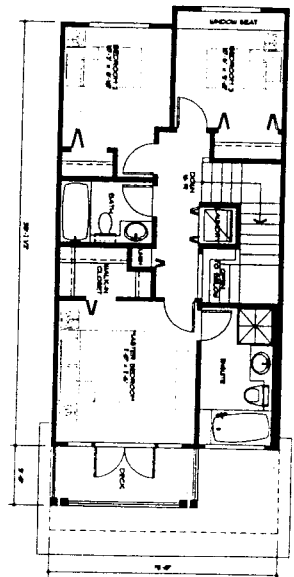
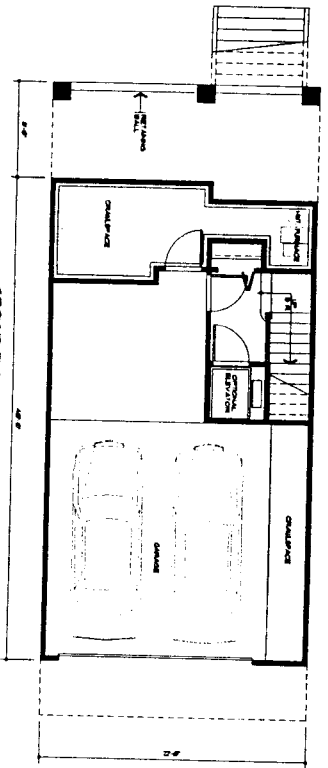
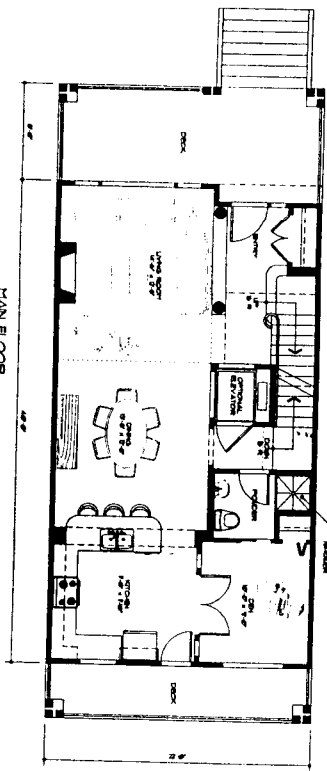

UNIT B
FLOOR AREA

Ground floor	87.4
Upper floor	48.3
TOTAL	135.7
Covered Deck	273.1
Accessories	28.0
Coverage	807.1

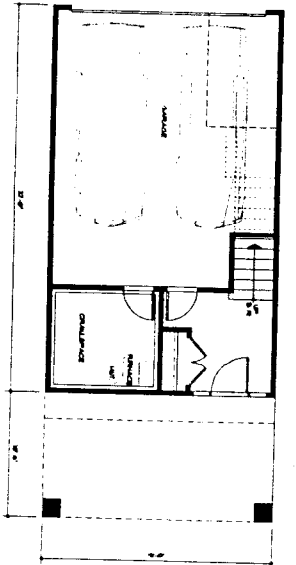
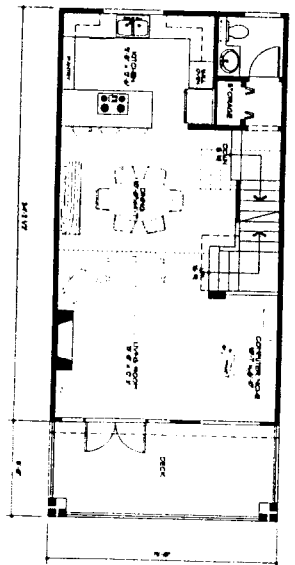

UNIT A & B
FLOOR PLANS
SCALE: 1/8" = 1'-0"

GROUND FLOOR

MAIN FLOOR

UPPER FLOOR

GROUND FLOOR

MAIN FLOOR

UPPER FLOOR

GARRY POINT PARK

1381
EDGE OF ASPHALT

7TH AVENUE

EDGE OF ASPHALT

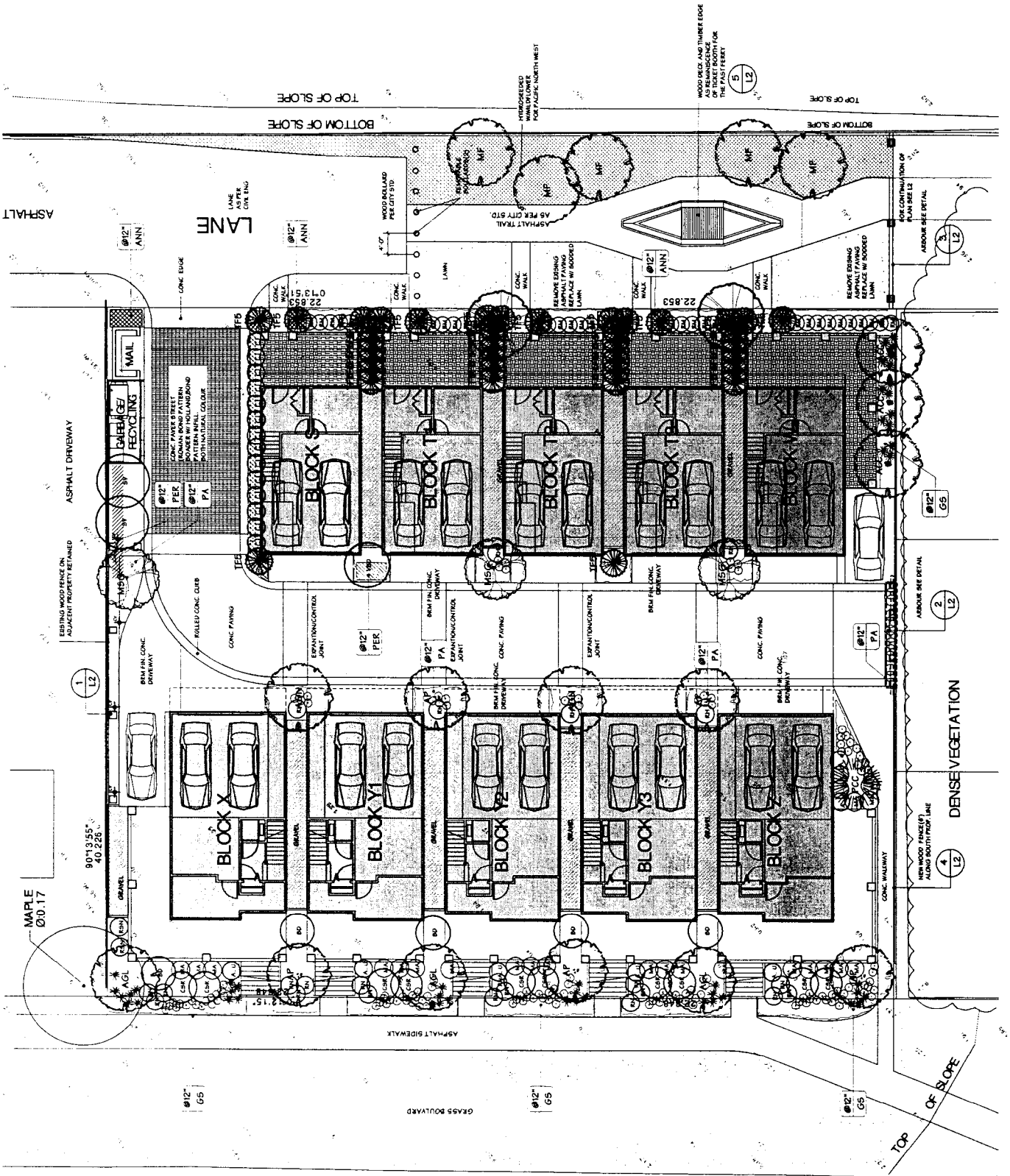

ASPHALT

LANE
SIDE
DIVE END

TOP OF SLOPE
BOTTOM OF SLOPE

TOP OF SLOPE
BOTTOM OF SLOPE

CONTRACTOR: J. J. JONES
DESIGNER: J. J. JONES
DATE: 10/1/11
PROJECT: 1381 GARRY POINT PARK
SHEET: L1 OF 2

JTO
JONES TOWNSEND & ASSOCIATES
LANDSCAPE ARCHITECTS
3180 HAVEN STREET
RICHMOND, B.C. V6V 2A4
PHONE: (604) 271-5658
FAX: (604) 271-5658
EMAIL: info@jto.ca

Project:
**7TH AVE.
STEVESTON
RICHMOND, B.C.**

Drawing Title:
LANDSCAPE PLAN

Client:	J. J. JONES
Contractor:	J. J. JONES
Designer:	J. J. JONES
Date:	10/1/11
Project:	1381 GARRY POINT PARK
Sheet:	L1 OF 2

L1
of 2

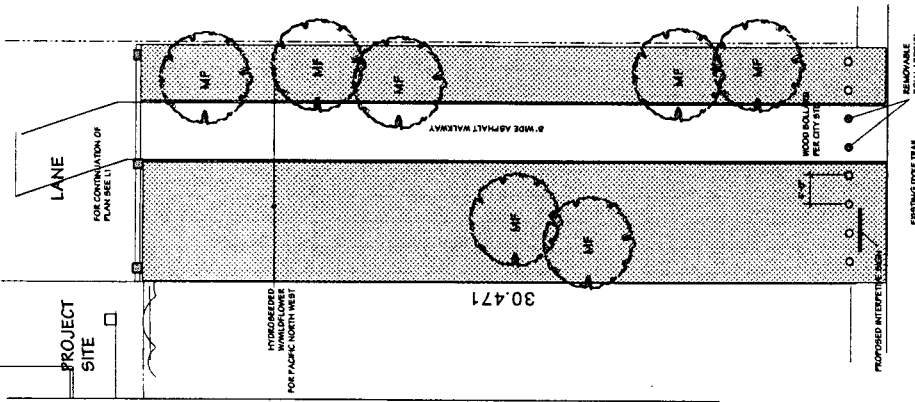

LANDSCAPE PLAN
DETAILS/
PLANT LIST

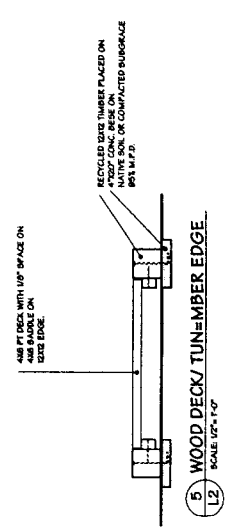

WOOD FENCE
SCALE 1/2" = 1'-0"

FERRY SIGN
SCALE 1/2" = 1'-0"

ELEVATION
SCALE 1/2" = 1'-0"

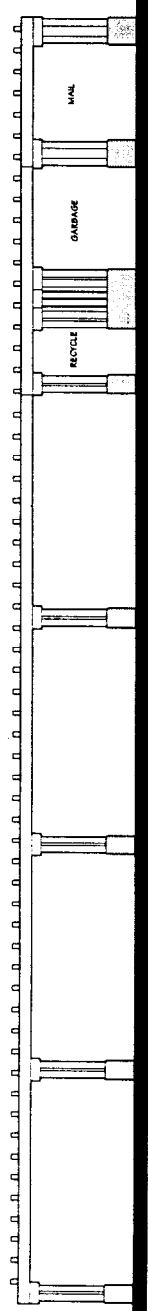
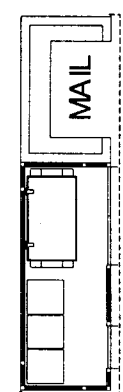

ARBOUR TYPE "A"
SCALE 1/2" = 1'-0"

SOUTH ELEVATION
SCALE 1/2" = 1'-0"

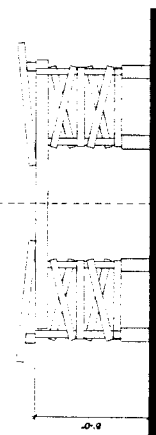
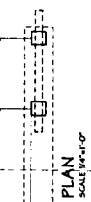

ARBOUR TYPE "B"
SCALE 1/2" = 1'-0"

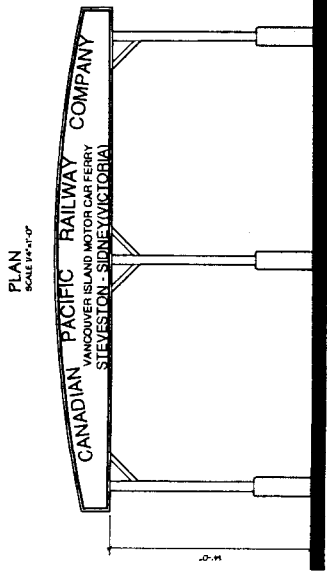
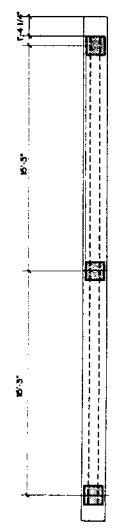

PLANT LIST
10080 7th Avenue, Richmond

NO.	QTY	SPECIES, NAME	COMMON NAME
1	1	MAHOGANY	MAHOGANY
2	1	DOGWOOD	DOGWOOD
3	1	DOGWOOD	DOGWOOD
4	1	DOGWOOD	DOGWOOD
5	1	DOGWOOD	DOGWOOD
6	1	DOGWOOD	DOGWOOD
7	1	DOGWOOD	DOGWOOD
8	1	DOGWOOD	DOGWOOD
9	1	DOGWOOD	DOGWOOD
10	1	DOGWOOD	DOGWOOD
11	1	DOGWOOD	DOGWOOD
12	1	DOGWOOD	DOGWOOD
13	1	DOGWOOD	DOGWOOD
14	1	DOGWOOD	DOGWOOD
15	1	DOGWOOD	DOGWOOD
16	1	DOGWOOD	DOGWOOD
17	1	DOGWOOD	DOGWOOD
18	1	DOGWOOD	DOGWOOD
19	1	DOGWOOD	DOGWOOD
20	1	DOGWOOD	DOGWOOD
21	1	DOGWOOD	DOGWOOD
22	1	DOGWOOD	DOGWOOD
23	1	DOGWOOD	DOGWOOD
24	1	DOGWOOD	DOGWOOD
25	1	DOGWOOD	DOGWOOD
26	1	DOGWOOD	DOGWOOD
27	1	DOGWOOD	DOGWOOD
28	1	DOGWOOD	DOGWOOD
29	1	DOGWOOD	DOGWOOD
30	1	DOGWOOD	DOGWOOD
31	1	DOGWOOD	DOGWOOD
32	1	DOGWOOD	DOGWOOD
33	1	DOGWOOD	DOGWOOD
34	1	DOGWOOD	DOGWOOD
35	1	DOGWOOD	DOGWOOD
36	1	DOGWOOD	DOGWOOD
37	1	DOGWOOD	DOGWOOD
38	1	DOGWOOD	DOGWOOD
39	1	DOGWOOD	DOGWOOD
40	1	DOGWOOD	DOGWOOD
41	1	DOGWOOD	DOGWOOD
42	1	DOGWOOD	DOGWOOD
43	1	DOGWOOD	DOGWOOD
44	1	DOGWOOD	DOGWOOD
45	1	DOGWOOD	DOGWOOD
46	1	DOGWOOD	DOGWOOD
47	1	DOGWOOD	DOGWOOD
48	1	DOGWOOD	DOGWOOD
49	1	DOGWOOD	DOGWOOD
50	1	DOGWOOD	DOGWOOD
51	1	DOGWOOD	DOGWOOD
52	1	DOGWOOD	DOGWOOD
53	1	DOGWOOD	DOGWOOD
54	1	DOGWOOD	DOGWOOD
55	1	DOGWOOD	DOGWOOD
56	1	DOGWOOD	DOGWOOD
57	1	DOGWOOD	DOGWOOD
58	1	DOGWOOD	DOGWOOD
59	1	DOGWOOD	DOGWOOD
60	1	DOGWOOD	DOGWOOD
61	1	DOGWOOD	DOGWOOD
62	1	DOGWOOD	DOGWOOD
63	1	DOGWOOD	DOGWOOD
64	1	DOGWOOD	DOGWOOD
65	1	DOGWOOD	DOGWOOD
66	1	DOGWOOD	DOGWOOD
67	1	DOGWOOD	DOGWOOD
68	1	DOGWOOD	DOGWOOD
69	1	DOGWOOD	DOGWOOD
70	1	DOGWOOD	DOGWOOD
71	1	DOGWOOD	DOGWOOD
72	1	DOGWOOD	DOGWOOD
73	1	DOGWOOD	DOGWOOD
74	1	DOGWOOD	DOGWOOD
75	1	DOGWOOD	DOGWOOD
76	1	DOGWOOD	DOGWOOD
77	1	DOGWOOD	DOGWOOD
78	1	DOGWOOD	DOGWOOD
79	1	DOGWOOD	DOGWOOD
80	1	DOGWOOD	DOGWOOD
81	1	DOGWOOD	DOGWOOD
82	1	DOGWOOD	DOGWOOD
83	1	DOGWOOD	DOGWOOD
84	1	DOGWOOD	DOGWOOD
85	1	DOGWOOD	DOGWOOD
86	1	DOGWOOD	DOGWOOD
87	1	DOGWOOD	DOGWOOD
88	1	DOGWOOD	DOGWOOD
89	1	DOGWOOD	DOGWOOD
90	1	DOGWOOD	DOGWOOD
91	1	DOGWOOD	DOGWOOD
92	1	DOGWOOD	DOGWOOD
93	1	DOGWOOD	DOGWOOD
94	1	DOGWOOD	DOGWOOD
95	1	DOGWOOD	DOGWOOD
96	1	DOGWOOD	DOGWOOD
97	1	DOGWOOD	DOGWOOD
98	1	DOGWOOD	DOGWOOD
99	1	DOGWOOD	DOGWOOD
100	1	DOGWOOD	DOGWOOD

NOTES:
1. SHOWER PAVEMENT AND FINISHES TO BE APPROVED BY THE LANDSCAPE ARCHITECT.
2. ALL MATERIALS AND METHODS SHALL BE IN ACCORDANCE TO THE MOST RECENT PRACTICES AND STANDARDS.
3. THE CONTRACTOR SHALL BE RESPONSIBLE FOR OBTAINING ALL NECESSARY PERMITS AND APPROVALS FROM THE LOCAL AUTHORITIES.
4. THE CONTRACTOR SHALL BE RESPONSIBLE FOR OBTAINING ALL NECESSARY PERMITS AND APPROVALS FROM THE LOCAL AUTHORITIES.
5. THE CONTRACTOR SHALL BE RESPONSIBLE FOR OBTAINING ALL NECESSARY PERMITS AND APPROVALS FROM THE LOCAL AUTHORITIES.
6. THE CONTRACTOR SHALL BE RESPONSIBLE FOR OBTAINING ALL NECESSARY PERMITS AND APPROVALS FROM THE LOCAL AUTHORITIES.
7. THE CONTRACTOR SHALL BE RESPONSIBLE FOR OBTAINING ALL NECESSARY PERMITS AND APPROVALS FROM THE LOCAL AUTHORITIES.
8. THE CONTRACTOR SHALL BE RESPONSIBLE FOR OBTAINING ALL NECESSARY PERMITS AND APPROVALS FROM THE LOCAL AUTHORITIES.
9. THE CONTRACTOR SHALL BE RESPONSIBLE FOR OBTAINING ALL NECESSARY PERMITS AND APPROVALS FROM THE LOCAL AUTHORITIES.
10. THE CONTRACTOR SHALL BE RESPONSIBLE FOR OBTAINING ALL NECESSARY PERMITS AND APPROVALS FROM THE LOCAL AUTHORITIES.

139

ITCO & ASSOCIATES
Landscape Architects
3180 Main Street
Richmond, BC V6E 2L4
Voice: (604) 275-2812
Fax: (604) 275-4206
Email: info@itco.ca

Project:
7TH AVE.
STEVENSON
RICHMOND, B.C.

Drawing Title:
LANDSCAPE PLAN
DETAILS/
PLANT LIST

Scale:
1/8" = 1'-0"

Date:
January 2nd, 2009

Sheet:
L2 of 2

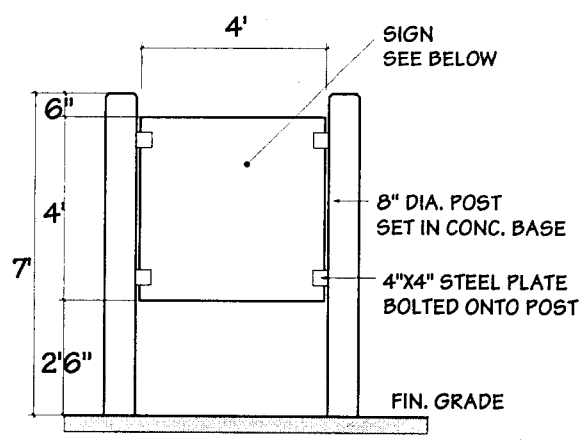
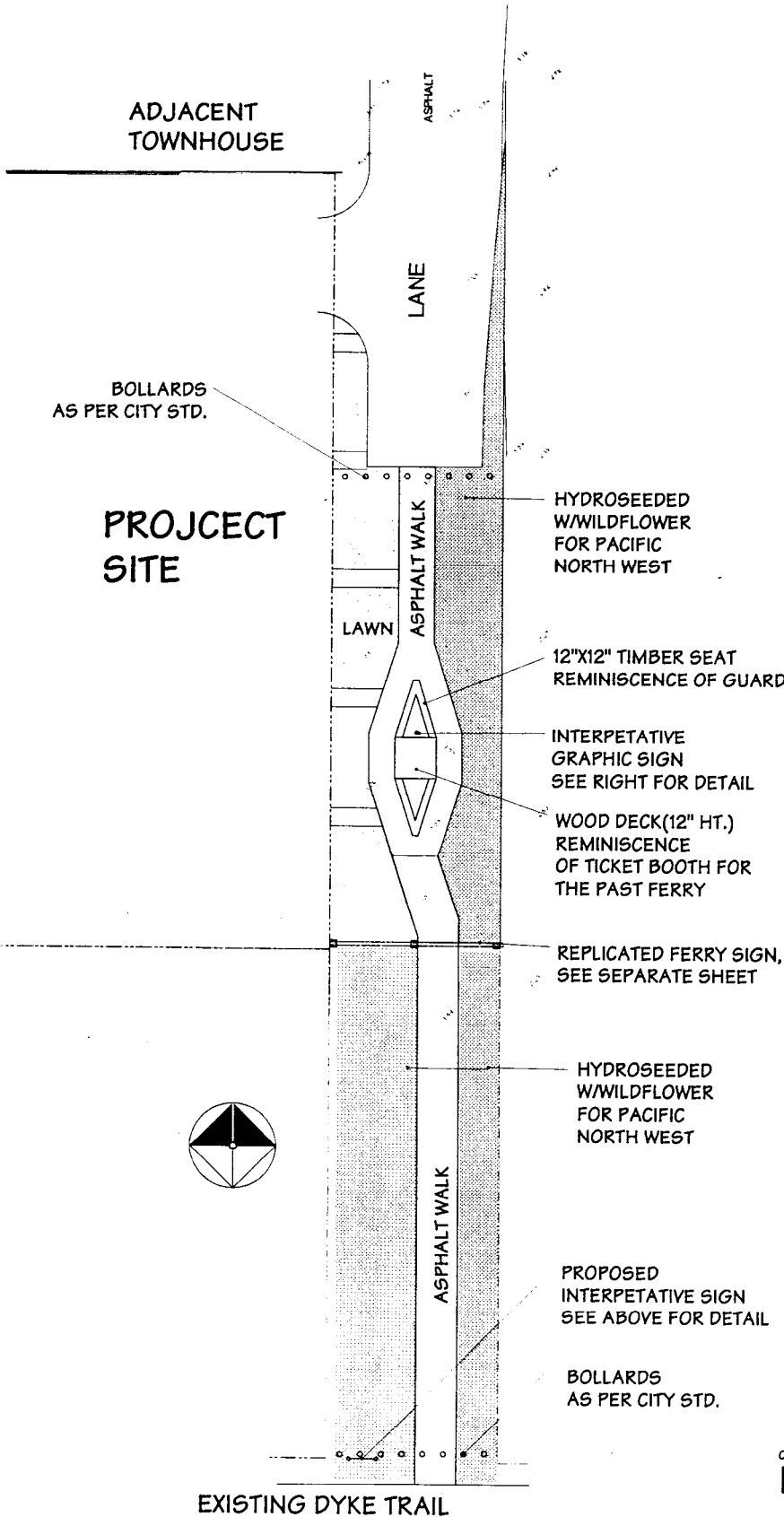

INTERPRETATIVE SIGN
SCALE: 1" = 1'-0"

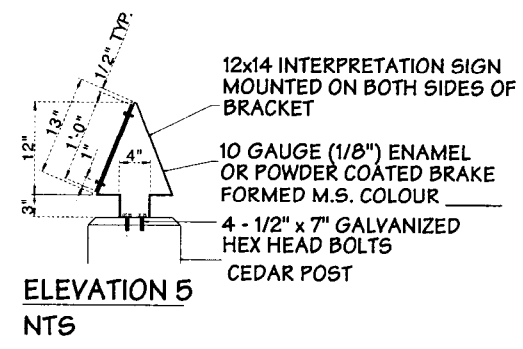

ELEVATION 5
NTS

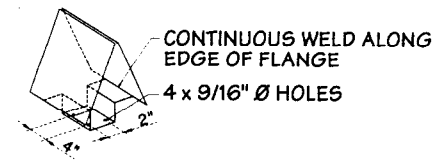

AXONOMETRIC
NTS
GRAPHIC SIGN

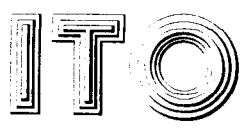
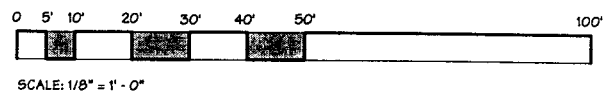

ITO & ASSOCIATES
Landscape Architects
Voice: 604-275-2811
Fax: 604-275-4836
Email: info@ito.ca
Address: 3180 Hume Street Richmond, B.C. V7E 3L4
ITO & ASSOC. JOB NO. 02L26

PROPOSED PUBLIC WALKWAY
SCALE: 1/8" = 1' - 0"
DATE: AUGUST 17 2003

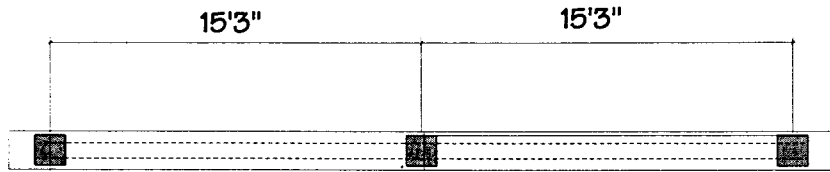

PLAN

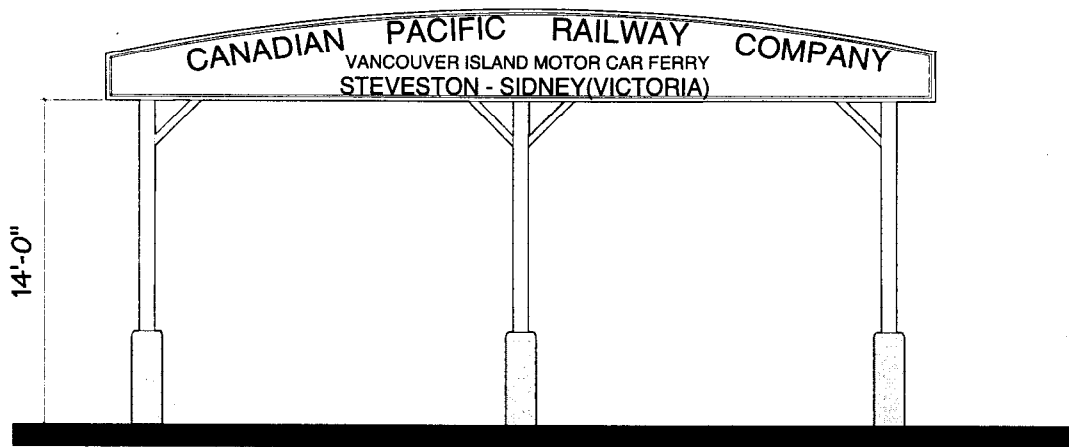

ELEVATION

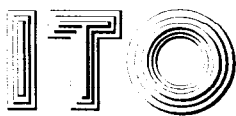

ITO & ASSOCIATES
 Landscape Architects
 Vancouver, B.C. V7E 2L4
 Phone: 604-275-2115
 Facsimile: 604-275-4826
 Email: info@ito.ca
 Address: 3180 Hunt Street, Richmond, B.C. V7E 2L4

ITO & ASSOC. JOB NO. 02L26

REPLICATED FERRY SIGN

14"

14"

12"



TICKET BOOTH

12"



FERRY FARE IN 1940

Steveston ~ Sidney AUTO FERRY 1029 - 1950

4'-0"

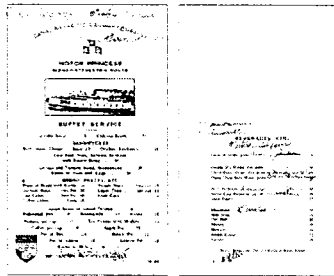

MENUE

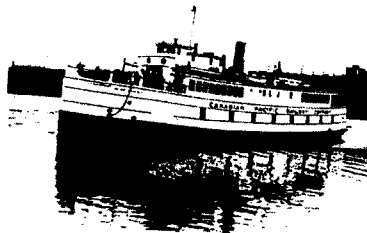

THE MOTOR PRINCESS

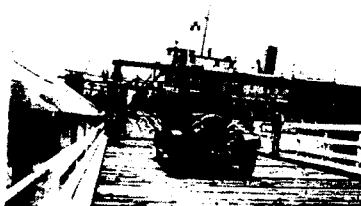

DOWNLOADING THE MOTOR PRINCESS
AT STEVESTON



FERRY TERMINAL

NOTE:

SERVICE ON THE STEVESTON - SIDNEY, VANCOUVER ISLAND, ROUTE WAS PROVIDED BY THE 1923 M.S. *MOTOR PRINCESS* BUILT AT THE YARROW SHIPYARD IN ESQUIMALT ON VANCOUVER ISLAND. THE 40 CAR VESSEL WAS THE FIRST DIESEL ENGINE SHIP BUILT BY CPR. AFTER RETIREMENT FROM THE STEVESTON - SYDNEY RUN IN 1950, THE *MOTOR PRINCESS* WAS USED FOR FREIGHT SERVICE.

4'-0"

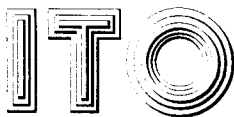

& ASSOCIATES
Landscape Architects

Voice: 604 275-7812
Fax: 604 275-7822
Email: info@ito.ca
Address: 3180 Hurt Street, Richmond, B.C. V7E 2L4

ITO & ASSOC. JOB NO. 02L26

INTERPRETATIVE SIGN

SCALE: 6" = 1' - 0"
DATE: AUGUST 17 2003

142

Richmond Heritage Inventory

Detailed Evaluation Worksheet

Stilt Piling House # 1

A. General Information

Type of Resource: Building

Address: 12080 Seventh Ave., Richmond, BC

Neighbourhood (Planning Area Name): Steveston

Construction Date: circa 1888-90

Current Owner: Private

Designated: No



B. Context

Local Name of Neighbourhood: Steveston.

Site Description: This house sits across the street from Garry Point Park. A townhouse complex is at the north end of the street, and boat docks are to the south. Immediately next door is another stilt house. Both properties are slated for demolition and appear neglected.

History: This area was one of the first in Richmond to be settled. It is assumed that the local cannery built a number of these houses for its workers.

C. Community Significance

Neighbourhood Value: Located in one of the first areas in Richmond to be settled, these are the last 2 houses of their kind. Both houses were originally built on stilts. It is assumed that the local cannery built a number of these houses for its workers. They represent the earliest European-based settlement in Richmond.

City-Wide Value: Both stilt houses hold more symbolic appeal than visual. See neighbourhood value section.

D. Architectural Significance (Built Forms Only)

Architectural Style: Stilt.

Building Type: Domestic.

Name of Architect or Builder: Unknown.

Design Features: Stilt house #1 is presumed to have a foundation of post and pilings. It currently has a low gable roof with a low gable covered porch off-centred on the front facade. Both the house roof and the porch roof have plain white fascias. The roofing material is grey asphalt. The windows on the main portion of the house are wooden, double-hung. The siding is wooden ship-lap with corner boards, painted blue. The area which would show the stilts have been covered with clapboard siding and plain corner boards to match the upper portion of the house.

Construction Method: Unconfirmed.

E. Landscape Significance

Landscape Element: Insignificant on preliminary observation.

143

F. Integrity

Alterations: This building has been completely hidden beneath a layering of dull material. The restoration required is extensive; but, worth it.

Original Location: Yes.

Condition: The condition of the original material is unknown at present.

G. Heritage Statement

Heritage Character Statement: The Steveston Hotel has consistently played an important role as a social gathering spot in Steveston, dating back to the turn of the 20th Century. Originally the Sockeye Hotel, this building was one of a number of rooming houses and drinking establishments in the Steveston commercial district. It draws further significance from the likelihood that it is the only establishment that has continuously operated as a hotel, food and beverage facility in Steveston. While alterations to the structure have significantly changed the aesthetics of the hotel, its prominence at the terminus of Steveston's main commercial street remains unchanged.

H. Documentation

1. Evaluated By: Julie MacDonald (Julie MacDonald Heritage Consulting).

2. Evaluation Date: February 15, 2000.

3. Photographer's Name: Julie MacDonald (Julie MacDonald Heritage Consulting).

4. Date of Photograph: February 15, 2000.

5. Documentation: "Heritage Inventory, Phase II" by Foundation Group Designs, May 1989. Inventory Sheets by Diana Bodnar (Foundation Group), January 1989.

Richmond Heritage Inventory

Detailed Evaluation Worksheet

Stilt Piling House #2

A. General Information

Type of Resource: Building
Address: 12080 Seventh Avenue, Richmond, BC
Neighbourhood (Planning Area Name): Steveston
Construction Date: c.1912
Current Owner: Private
Designated: No

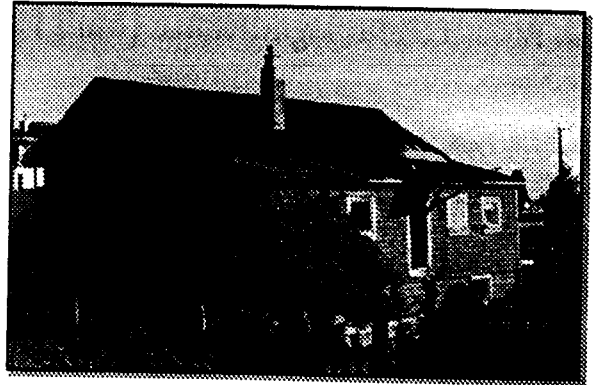

B. Context

Local Name of Neighbourhood: Steveston.

Site Description: This house is located across the street from Garry Point Park on Seventh Avenue. To the north is a warehouse building and a condominium complex; to the south is a large storage area for fishing equipment, boat mooring docks, and the river. Immediately adjacent on the south side is another, earlier stilt constructed house at 12100 Seventh Avenue. The house has a small fenced yard and an adjacent ditch which runs along Seventh Avenue. An interesting feature of this house is its aspect, as it does not face the street, but faces south towards the river.

History: This area of Richmond was one of the first to be settled, due in part to the rich fishery of the Fraser River. Canneries began to be built along Cannery Channel in the late 1800s, and it is assumed that a number of these houses were built in this area for workers and their families. This house was originally located adjacent to the Garry Point Cannery c.1888-1890.

C. Community Significance

Neighbourhood Value: Located in Steveston, one of the first areas of Richmond to be settled by Europeans, this house and its immediate neighbour are among the last remaining houses originally raised on stilt pilings to allow for water drainage underneath. They have an immediate association with the early fishery and of the extensive cannery activities in this area of Steveston. It is assumed that they were built by the canneries to house local workers.

City-Wide Value: The story of the west coast fishery and Richmond's place in it is as important to the region as it is to the neighbourhood. The two stilt houses represent a small precinct which evokes a past way of life and are important reminders of the early history of the area.

Ethnic Significance: There may be some significance in this building type for those people of First Nations, European and Asian origin who made their living in the Fraser River fishery.

D. Architectural Significance (Built Forms Only)

Architectural Style: Vernacular Stilt House.

Building Type: Single Family Domestic.

Name of Architect or Builder: Unknown.

Design Features: The building is rectangular in shape with a concrete perimeter foundation and an irregular roof line. The roof is a front gable with a dual pitch or shed style addition on the south side. The roof cover is asphalt shingle. There is a flat hood roof over the door and an internal brick chimney. Windows are multi-paned double-hung wooden sash six over six on the north and west facades, and single pane pivot on the south facade. The banked multi-paned windows on the north facade are an unusual feature of this house type. The exterior cladding is cedar shingle with corner boards above and horizontal clapboard below. The cladding is not considered to be original.

Construction Method: Wood frame construction. A unique building feature is the original post/piling foundation.

E. Landscape Significance

Landscape Element: The most significant landscape element associated with the house is the presence of the dyke system along Seventh Avenue. The small yard, fence and vegetation appear to be recent additions.

F. Integrity

Alterations: The shingle siding of the house is not original. Alterations have occurred to the entry and porch. The shed roof on the south side indicates a possible addition or the enclosure of an open verandah. The basement is assumed to be a later enclosure around the stilt piling construction. The changes in the immediate vicinity of the house make it appear to be out of context.

Original Location: Yes.

Condition: The house is in fair condition. The fence and yard are fairly well maintained. This house and its neighbour are under threat due to continued deterioration and neglect.

G. Heritage Statement

Heritage Character Statement: This small house and its immediate neighbour evoke a sense of the past by their association with the day to day domestic lives of fishers and cannery workers and their families. Among the last of its kind, it represents the building type and stilt construction method of employee housing that once proliferated along Steveston's Cannery Channel, and which was designed to contend with flood plain conditions and the lack of adequate dyke protection during the early days of the Steveston fishery. It is part of a pattern of housing oriented towards the fishing boat docks and the Fraser River.

H. Documentation

1. **Evaluated By:** Denise Cook, BLA, PBD (Public History).
2. **Evaluation Date:** September 24, 2000.
3. **Photographer's Name:** Denise Cook.
4. **Date of Photograph:** September 24, 2000.
5. **Documentation:** Inventory Sheets by Foundation Group Designs, January 1990.
City of Richmond Heritage Inventory by Julie MacDonald, February 2000.

Mr. Wayne Fougere, architect for the development at the south foot of 7th Avenue, and Mr. Bob Snowball, developer, were present. With the aid of a model Mr. Fougere presented a project proposed for sites on 7th Avenue in Steveston that currently contain 2 historic buildings that are to be moved to the Britannia Heritage Shipyard. A contribution made by Mr. Snowball to the cost of moving the houses, as clarified by Ms. Baxter, was to be in the amount of \$5,000. less the cost of residual clean up of the site.

Mr. Fougere pointed out that the lane to the east of the property, which is known as Ferry Road, was actually a 33 ft. right-of-way, a half road standard that was the original connection to Vancouver Island ferry. Photographs of the original signage and ticket booth were in the possession of the Planning Department.

Located in the middle of Ferry Road is the original concrete foundation for the ticket booth and a trestle that marked the old ramp for accessing the ferry (Bob Ransford said that the trestle was in fact a turntable). Mr. Fougere suggested that the heritage sign of the site be re-created and the other heritage remaining be provided with interpretative signage. The new homes have been designed in clusters of five with wrap around porches containing piers down to give the imagery of the original stilt houses.

A discussion then ensued on the concept, including the possible raising of the road grade on Ferry Road; the possibility of Ferry Road being signed; the feasibility of allowing parking on Ferry Road; and, interpretative signage. It was determined that the primary focus should be the preservation of the heritage artefacts especially as not a lot of artefacts from the ferry, which had a huge impact on the local economy of its day, remain; that preference was for no parking in front of the properties on Ferry Road; and, that interpretative signage was very important to sharing this piece of history with Steveston.

As a result of the discussion:

It was moved and seconded

- 1. That the Commission requests that during approval of the proposed development, consideration be given to preserving the heritage artefacts that remain adjacent to the development site and represent the remnants of the original Vancouver Island Ferry terminal; and,***
- 2. That the Commission endorses the concept of the City accepting the offer of the developer to construct a replica of the original terminal signage and that the design of the same be co-ordinated as part of the existing trail signage and heritage interpretive signage.***

CARRIED

4. 2003-26

Townhouses*Wayne Fougere*7th Avenue

(Formal)

DP 03-239178

Mr. Brian Guzzi distributed and reviewed preliminary staff comments on the project, a copy of which is attached as Schedule 4 and forms a part of these minutes.

Mr. Fougere, with the aid of a model, site plan, elevations, materials board and an artists' renderings, then reviewed the project. Six of the units are currently sold. The stilt pile houses currently located on the site are to be relocated to the Britannia Heritage Shipyard. The elements were reviewed with the note that variety in the back lane was not necessary as it was not possible to see the project as one view. Three different materials had been utilized on each building – horizontal siding, board and batton, and stuccoed board and batton – in varying colours.

Mr. Ito reviewed elements of historical significance that had been incorporated into the project at the end of the drive aisle and along in the lane.

Mr. Fougere noted that five on the larger homes along 7th Avenue had incorporated space for an elevator shaft.

The comments of the Panel were as follows:

- a nice project – good treatments. The use of gravel between the buildings was questioned and ground cover was suggested as a alternative.
- Cst. Powroznik distributed written comments, a copy of which is attached as Schedule 5 and forms a part of these minutes. The mail area should not be on the back lane. This area is too isolated and it will be vulnerable to break in and thefts. Wherever the mail area is located it should not be enclosed on three sides. It should be open to the street or pedestrians walking by. There is a makeshift, unplanned path on the northwest corner of the property. It appears that the residents on the property to the north use this path. Perhaps the planned walkway could be moved to the north side and make it accessible for the residents of the neighbouring property as well. Ensure that there is lighting in the walkway to the east of the development.
- a nice project.
- delightful. The variety in the roof forms was appreciated as was the built form variety in the street wall.

- it was acknowledged that the centre did not require articulation. The lack of amenities for the project was noted, but the proximity of the park mitigated this. The gravel between the buildings was considered appropriate.
- a great project.
- the previous comments were agreed to. The calliper sizes of the proposed trees was questioned.
- the provision of space for future elevator shafts was complimented. The applicant was also credited for the layout of the master bedroom ensuite – it was requested that backing board be provided alongside the commode.
- the previous comments were echoed. The lack of green space was again noted. Mr. Fougere responded that initial interest in the project had not indicated a problem over this – in addition, increased deck space had been provided. A grasscrete surface was suggested for the entry – Mr. Fougere said that he would convey this request to the developer.

It was also requested that other initiatives for the elderly, such as plugs/switches etc., be considered.

The unanimous decision of the Panel was that the project move forward subject to the above noted comments.

August 21, 2003

Urban Development Division
City of Richmond
6911 No. 3 Road
Richmond, BC V6Y 2C1

**FOUGERE
ARCHITECTURE**
INC.
MEMBER OF THE ARCHITECTURAL INSTITUTE OF BRITISH COLUMBIA

Attention: David Brownlee, Planner 2

Dear Mr. Brownlee,

Re: 12060 - 12100 Seventh Avenue (Rezoning Application #RZ 03-223904)

Further to your conversation with Wayne Fougere regarding the archaeological investigations that have been carried out for the above noted project I have attached for your information a copy of the approval from the Ministry of Sustainable Resource Management. Should you wish to see the correspondence between Mr. Ham and Mr. Suttill please give me a call and I will forward the appropriate documents.

Yours sincerely,

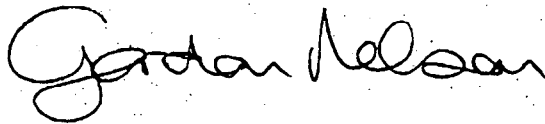

Gordon Nelson

Cc. Bob Snowball

Encl.

151



24600-65/RICH

23 July 2003

Leonard C. Ham, Ph.D., RPCA
Archaeologist & Heritage Consultant
1141 Walalee Drive
Delta, BC V4M 2L9

Dear Len Ham:

**Re: Results of Backhoe Testing in Vicinity of DgRt 1
(Lots 14 & 15 Seventh Ave, Steveston)**

Thank you for your letter of 2003/05/29 concerning the above development and the site form update for archaeological site DgRt 1.

Based on your findings, and previous information from this area, the Archaeology and Registry Services Branch agrees that no further archaeological investigations are warranted for development of these 2 properties. As usual, if anything of suspected archaeological significance were to be found, our office should be contacted.

Yours truly,

David Suttill
Heritage Resource Specialist
Archaeological Planning & Assessment

cc Mr. Bob Snowball
10995 Springmont Gate
Richmond, BC V7E 1Y5



**Richmond Official Community Plan Bylaw 7100
Amendment Bylaw 7605 (RZ03-223904)
12060/12080/12086/12100 7TH AVENUE**

The Council of the City of Richmond, in open meeting assembled, enacts as follows:

- 1. Richmond Official Community Plan Bylaw 7100 is amended by repealing the existing land use designation in Attachment 1 to Schedule 1 thereof of the following area and by designating it Neighbourhood Residential.

P.I.D. 012-835-391

Parcel A Section 10 Block 3 North Range 7 West New Westminster District Reference Plan 80025

P.I.D. 002-183-854

Lot 14A Block 14 Section 10 Block 3 North Range 7 West New Westminster District Plan 249

P.I.D. 002-183-889

Lot 15B Block 14 Section 10 Block 3 North Range 7 West New Westminster District Plan 249

P.I.D. 004-503-589

Lot 15A Block 14 Section 10 Block 3 North Range 7 West New Westminster District Plan 249

- 2. This Bylaw may be cited as “**Richmond Official Community Plan Bylaw 7100, Amendment Bylaw 7605**”.

FIRST READING

PUBLIC HEARING

SECOND READING

THIRD READING

ADOPTED

CITY OF RICHMOND
APPROVED for content by originating Dept
<i>[Signature]</i>
APPROVED for legality by Solicitor
<i>[Signature]</i>

MAYOR

CITY CLERK



**Richmond Zoning and Development Bylaw 5300
Amendment Bylaw 7606 (RZ 03-223904)
12060, 12080, 12086 & 12100 7TH AVENUE**

The Council of the City of Richmond, in open meeting assembled, enacts as follows:

1. Richmond Zoning and Development Bylaw 5300 is amended by inserting as Section 291.78 thereof the following:

“291.78 COMPREHENSIVE DEVELOPMENT DISTRICT (CD/78)

The intent of this zoning district is to accommodate up to ten single-family character townhouses with a heritage appearance.

291.78.1 PERMITTED USES

RESIDENTIAL, limited to **One-Family Dwelling** and **Townhouses**;
BOARDING & LODGING, limited to two persons per **dwelling unit**;
HOME OCCUPATION;
COMMUNITY USE;
ACCESSORY USES, but excluding **secondary suites**.

291.78.2 PERMITTED DENSITY

.01 Maximum Floor Area Ratio:

- (a) For **One-Family Dwellings**: 0.55; together with an additional 50 m² (538.21 ft²) for use as **accessory buildings** and off-street parking.
- (b) For **Townhouses**: 0.784
- (c) For the purposes of Section 291.78.2.01(b), **floor area ratio** shall be deemed to exclude the floor area of those parts of the **building used** for off-street parking purposes or unenclosed balconies or porches.

291.78.3 MAXIMUM LOT COVERAGE: 50.4%

291.78.4 MINIMUM SETBACKS FROM PROPERTY LINES

- .01 Front Yard: 4.5m (14.764 ft.) EXCEPT** for porches which may project into the front yard for a distance of not more than

2.5 m (8.202 ft.) and stairs which may extend up to the front property line.

- .02 **Side Yards:** 3.0 m (9.843 ft.) EXCEPT for porches which may project into the side yard for a distance of not more than 2.0 m (6.562 ft.).
- .03 **Rear Yards:** 3.8 m (12.467 ft.) EXCEPT for porches which may project into the rear yard for a distance of not more than 2.4 m (7.874 ft.).

291.78.5 MAXIMUM HEIGHTS

- .01 **Buildings:**
 - (a) for buildings facing the rear lane: 10.84 m (35.564 ft) as measured from the lowest horizontal floor in the building.
 - (b) for buildings facing 7th Avenue: 11.22 m (36.811 ft) as measured from the lowest horizontal floor in the building.
- .02 **Structures:** 20 m (65.617 ft.).
- .03 **Accessory Buildings:** 5 m (16.404 ft.).

291.78.6 MINIMUM LOT SIZE

- .01 A **building** shall not be constructed on a **lot** having a width of less than 30 m (98.425 ft.) or a depth of less than 35 m (114.829 ft.); EXCEPT THAT a **One-Family Dwelling** may be constructed on a **lot** of not less than 270 m² (2,906.35 ft²) in area.
- .02 Regulations which determine the minimum dimensions and area of a **lot** which may be created by subdivision will be found in Division 600 of this bylaw.

291.78.7 OFF-STREET PARKING

- .01 Off-street parking shall be provided, developed and maintained in accordance with Division 400 of this Bylaw.”

2. The Zoning Map of the City of Richmond, which accompanies and forms part of Richmond Zoning and Development Bylaw No. 5300, is amended by repealing the existing zoning designation of the following area and by designating it **Comprehensive Development District (CD/78)**:

P.I.D. 012-835-391
Parcel A Section 10 Block 3 North Range 7 West New Westminster District Reference
Plan 80025

P.I.D. 002-183-854
Lot 14A Block 14 Section 10 Block 3 North Range 7 West New Westminster District
Plan 249

P.I.D. 002-183-889
Lot 15B Block 14 Section 10 Block 3 North Range 7 West New Westminster District
Plan 249

P.I.D. 004-503-589
Lot 15A Block 14 Section 10 Block 3 North Range 7 West New Westminster District
Plan 249

- 3. This Bylaw may be cited as **“Richmond Zoning and Development Bylaw 5300, Amendment Bylaw 7606”**.

FIRST READING

PUBLIC HEARING

SECOND READING

THIRD READING

OTHER CONDITIONS SATISFIED

ADOPTED

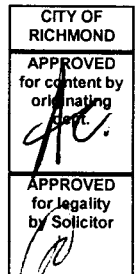

MAYOR

CITY CLERK